

**AZzardo**<sup>®</sup>

TRACKLINE

[www.azzardolighting.com](http://www.azzardolighting.com)

NAMING OF BASIC ACCESSORIES FOR TRACK MAGNETIC - GAMMA

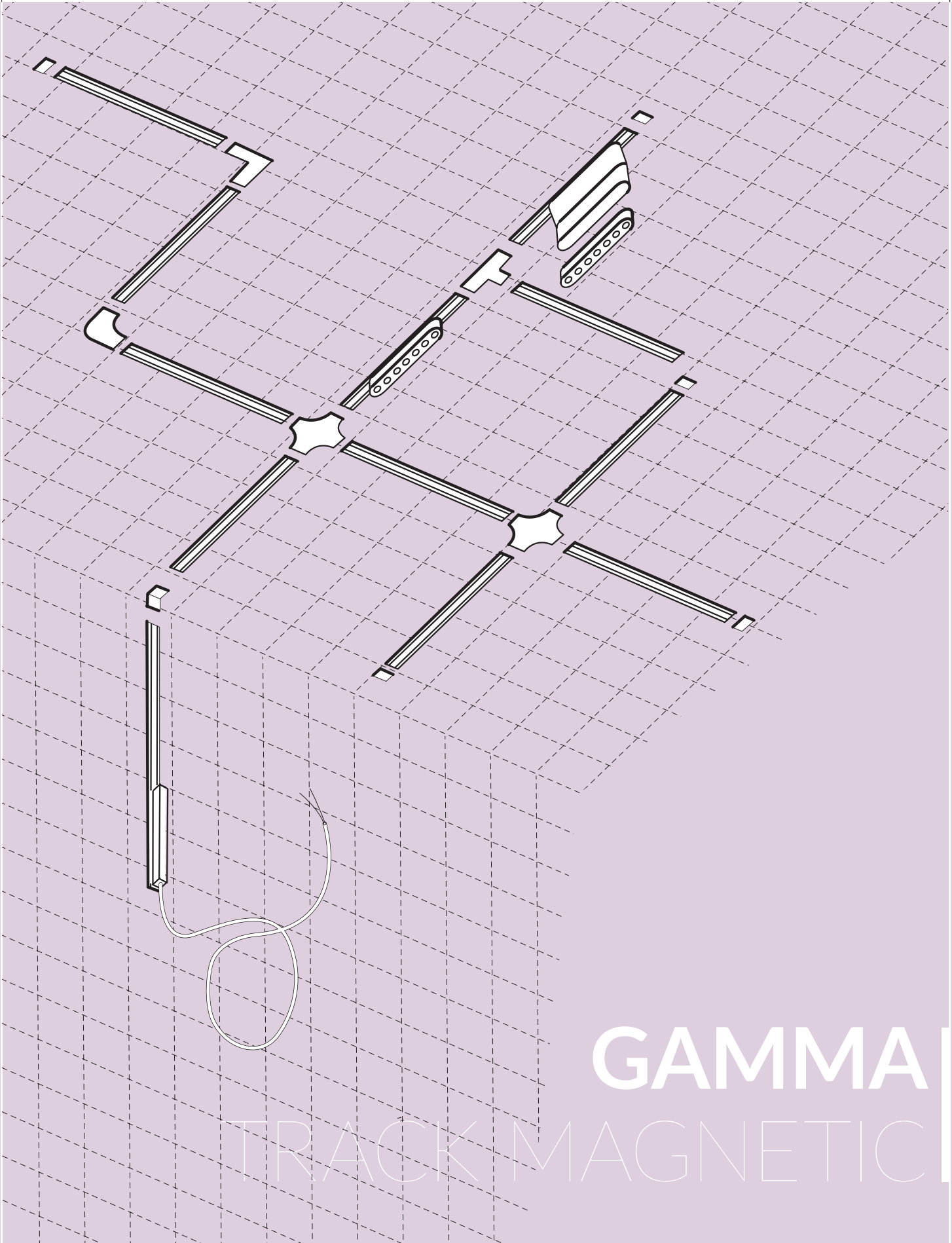

GAMMA

TRACK MAGNETIC

# GAMMA

## Track magnetic

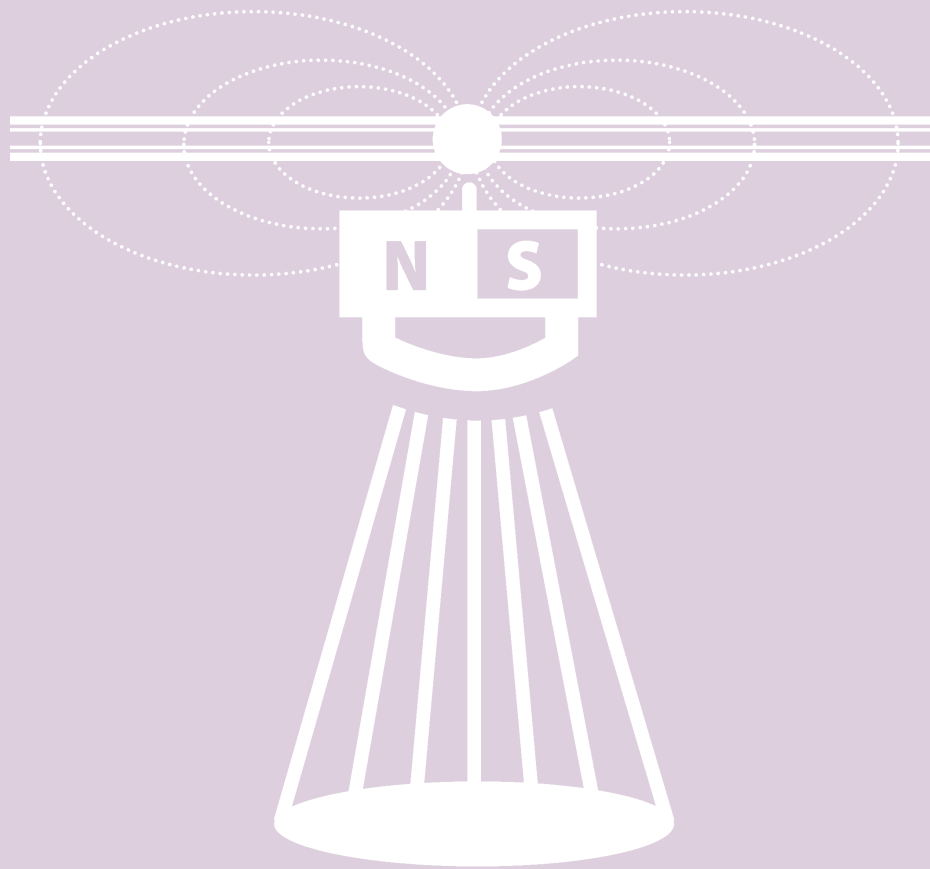

# GAMMA TRACK MAGNETIC 5MM

## 2 Components for GAMMA Track Magnetic

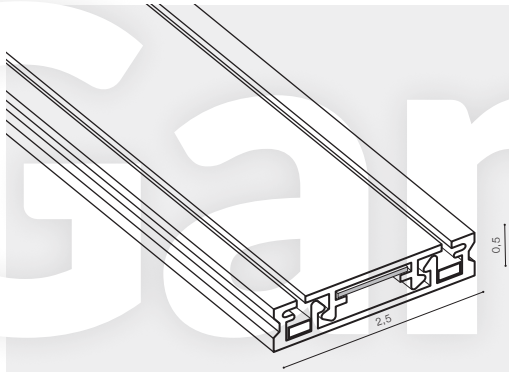

Example of the connection between track

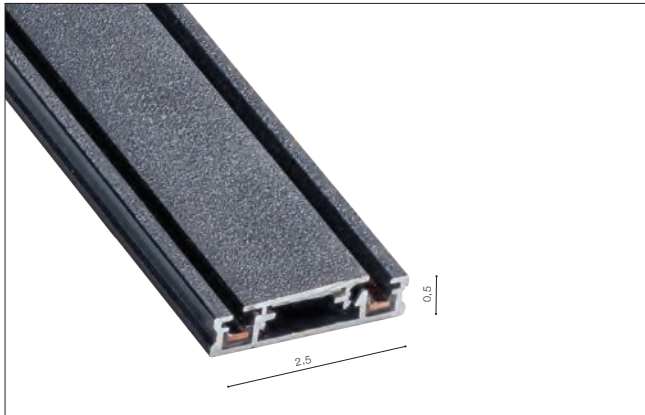
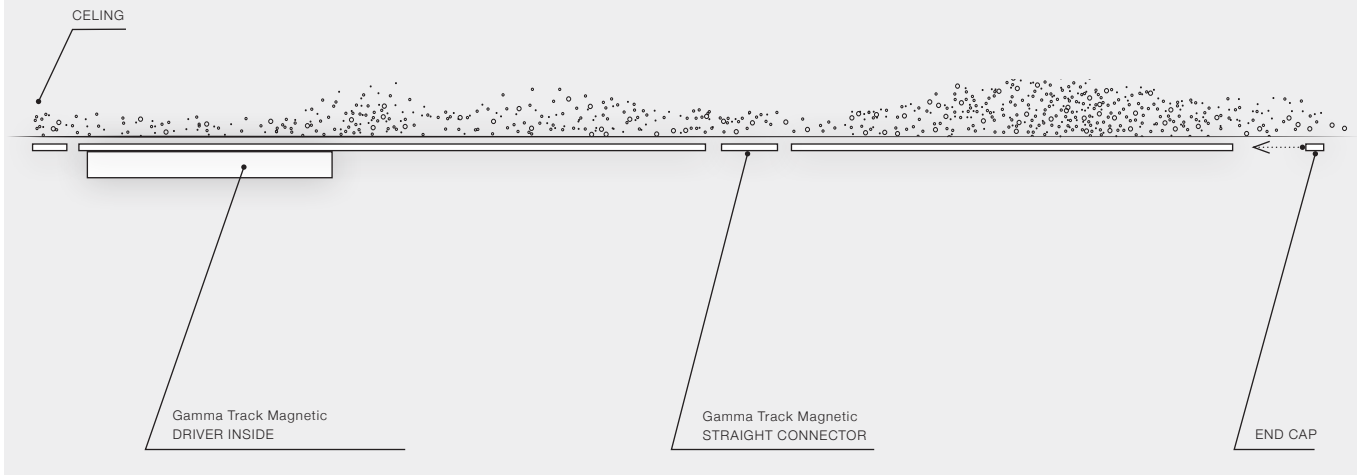

### GAMMA TRACK MAGNETIC BK (1m, 2m)

- GAMMA TRACK MAGNETIC 5MM 1M (BLACK) ..... **AZ5312**
- GAMMA TRACK MAGNETIC 5MM 1M (WHITE) ..... **AZ5314**
- GAMMA TRACK MAGNETIC 5MM 2M (BLACK) ..... **AZ5313**
- GAMMA TRACK MAGNETIC 5MM 2M (WHITE) ..... **AZ5315**

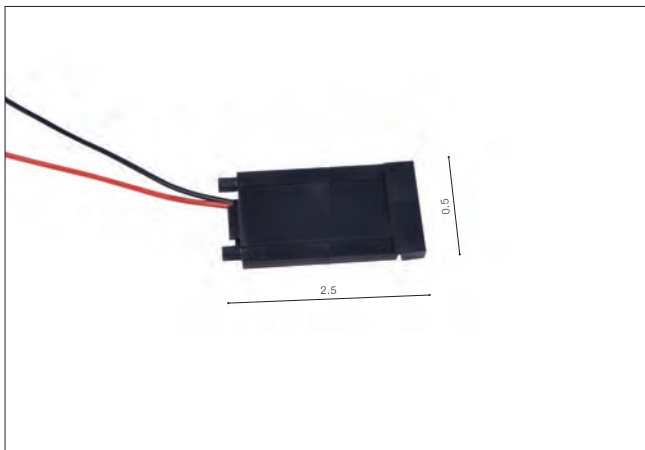
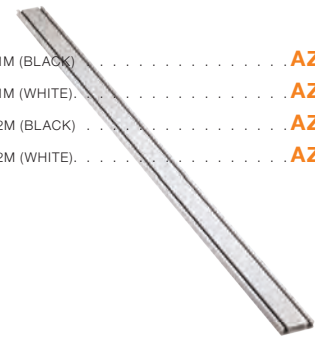

### GAMMA TRACK MAGNETIC DRIVER CONNECTOR

- GAMMA TRACK MAGNETIC 5MM DRIVER CONNECTOR (BLACK) ..... **AZ5328**
- GAMMA TRACK MAGNETIC 5MM DRIVER CONNECTOR (WHITE) ..... **AZ5329**

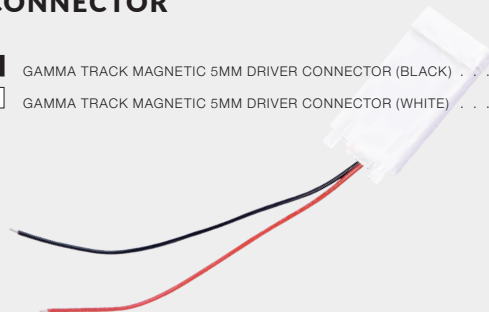

# SERIES

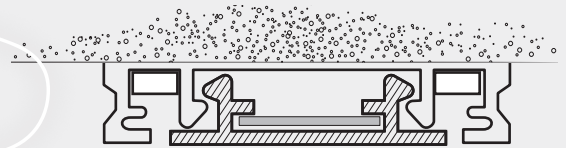

## Example of the connection between track

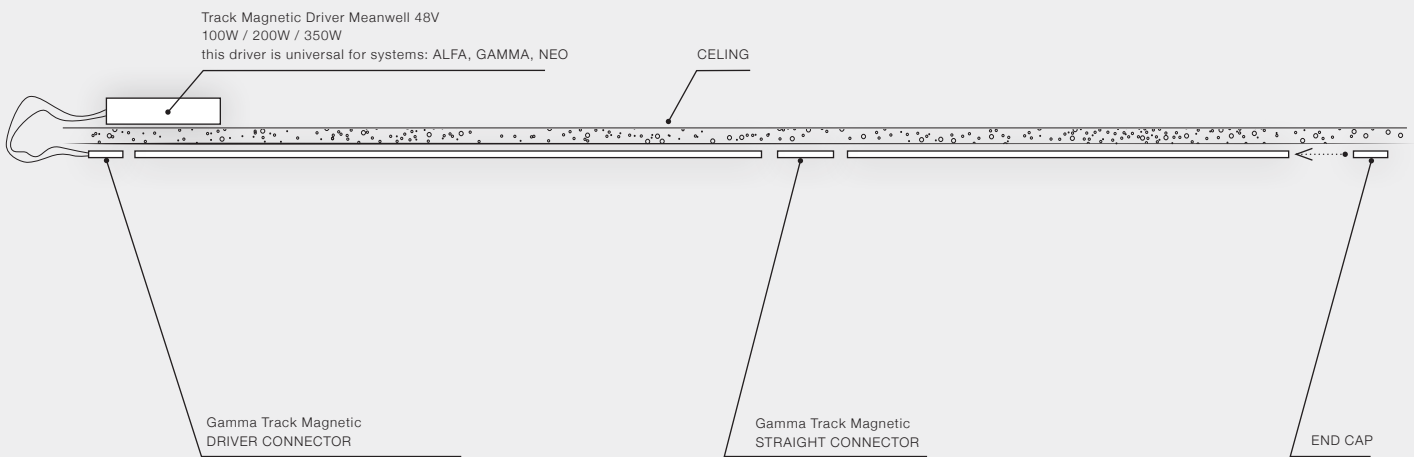

## GAMMA TRACK MAGNETIC DRIVER INSIDE 100W, 200W

- GAMMA TRACK MAGNETIC 5MM DRIVER INSIDE 100W (BLACK) . . . . . **AZ5330**
- GAMMA TRACK MAGNETIC 5MM DRIVER INSIDE 100W (WHITE) . . . . . **AZ5331**
- GAMMA TRACK MAGNETIC 5MM DRIVER INSIDE 200W (BLACK) . . . . . **AZ5332**
- GAMMA TRACK MAGNETIC 5MM DRIVER INSIDE 200W (WHITE) . . . . . **AZ5333**



## TRACK MAGNETIC DRIVER MEANWELL 48V 100W / 200W / 350W THIS DRIVER IS UNIVERSAL FOR SYSTEMS: ALFA, GAMMA, NEO

- DRIVER MEANWELL (100W) . . . . . **AZ4691**
- DRIVER MEANWELL (200W) . . . . . **AZ4692**
- DRIVER MEANWELL (350W) . . . . . **AZ4866**



# GAMMA TRACK MAGNETIC 5MM

## 4 Accessories for GAMMA Track Magnetic



### GAMMA TRACK MAGNETIC ADAPTER SMALL

■ GAMMA TRACK MAGNETIC 5MM ADAPTER SMALL (BLACK) . . . . . **AZ5310**



### GAMMA TRACK MAGNETIC ADAPTER BIG

■ GAMMA TRACK MAGNETIC 5MM ADAPTER BIG (BLACK) . . . . . **AZ5311**

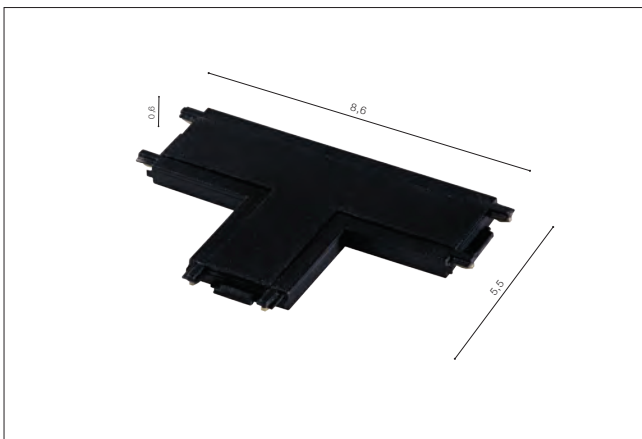

### GAMMA TRACK MAGNETIC T CONNECTOR

■ GAMMA TRACK MAGNETIC 5MM T CONNECTOR (BLACK) . . . . . **AZ5316**

□ GAMMA TRACK MAGNETIC 5MM T CONNECTOR (WHITE) . . . . . **AZ5317**



### GAMMA TRACK MAGNETIC X CONNECTOR

■ GAMMA TRACK MAGNETIC 5MM X CONNECTOR (BLACK) . . . . . **AZ5318**

□ GAMMA TRACK MAGNETIC 5MM X CONNECTOR (WHITE) . . . . . **AZ5319**



**GAMMA TRACK MAGNETIC STRAIGHT CONNECTOR**

- GAMMA TRACK MAGNETIC 5MM STRAIGHT CONNECTOR (BLACK) . . . . . **AZ5320**
- GAMMA TRACK MAGNETIC 5MM STRAIGHT CONNECTOR (WHITE) . . . . . **AZ5321**



**GAMMA TRACK MAGNETIC INNER CORNER90**

- GAMMA TRACK MAGNETIC 5MM INNER CORNER90 (BLACK) . . . . . **AZ5322**
- GAMMA TRACK MAGNETIC 5MM INNER CORNER90 (WHITE) . . . . . **AZ5323**

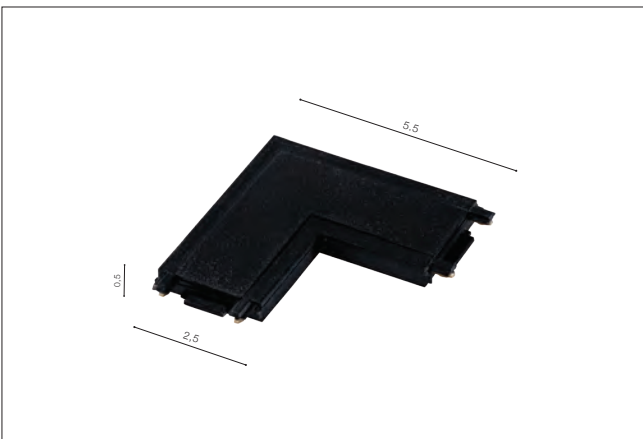

**GAMMA TRACK MAGNETIC L CONNECTOR**

- GAMMA TRACK MAGNETIC 5MM L CONNECTOR (BLACK) . . . . . **AZ5324**
- GAMMA TRACK MAGNETIC 5MM L CONNECTOR (WHITE) . . . . . **AZ5325**



**GAMMA TRACK MAGNETIC ROUND CORNER90**

- GAMMA TRACK MAGNETIC 5MM ROUND CORNER90 (BLACK) . . . . . **AZ5326**
- GAMMA TRACK MAGNETIC 5MM ROUND CORNER90 (WHITE) . . . . . **AZ5327**

# GAMMA KIRA TRACK MAGNETIC 5MM

## 6 Track Magnetic System - GAMMA



**GAMMA TRACK MAGNETIC 5MM 12W**  
3000K/4000K LED integrated

voltage: 48 V	LED 18W 1080 lm 3000K	
IP20	LED 18W 1140 lm 4000K	
technical specification	installation: GAMMA Track Magnetic 5mm beam angle: 24°	

COLOUR / NEW INDEX NO.

- 3000K BLACK (BK) . . . . . **AZ5290**
  - 4000K BLACK (BK) . . . . . **AZ5291**
- 

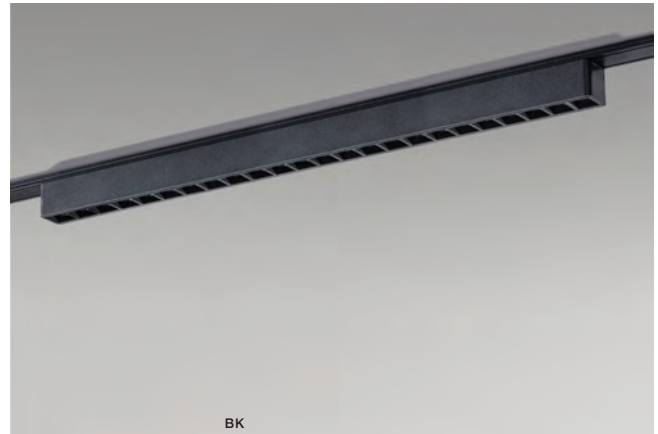

**GAMMA TRACK MAGNETIC 5MM 24W**  
3000K/4000K LED integrated

voltage: 48 V	LED 24W 1440 lm 3000K	
IP20	LED 24W 1500 lm 4000K	
technical specification	installation: GAMMA Track Magnetic 5mm beam angle: 24°	

COLOUR / NEW INDEX NO.

- 3000K BLACK (BK) . . . . . **AZ5296**
  - 4000K BLACK (BK) . . . . . **AZ5297**
- 



**GAMMA TRACK MAGNETIC 5MM 18W**  
3000K/4000K LED integrated

voltage: 48 V	LED 18W 1080 lm 3000K	
IP20	LED 18W 1140 lm 4000K	
technical specification	installation: GAMMA Track Magnetic 5mm beam angle: 24°	

COLOUR / NEW INDEX NO.

- 3000K BLACK (BK) . . . . . **AZ5293**
  - 4000K BLACK (BK) . . . . . **AZ5294**
-



# GAMMA NIKO TRACK MAGNETIC 5MM

Track Magnetic System – GAMMA 7



BK

## GAMMA NIKO TRACK MAGNETIC 5MM 7W

3000K/4000K

LED integrated

voltage: 48 V

LED 7W 420 lm 3000K

LED

IP20

LED 7W 480 lm 4000K

technical

installation: GAMMA Track Magnetic 5mm

specification

beam angle: 24°



COLOUR / NEW INDEX NO.

- 3000K BLACK (BK) . . . . . **AZ5284**
- 4000K BLACK (BK) . . . . . **AZ5285**

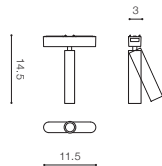

BK

## GAMMA NIKO TRACK MAGNETIC 5MM 12W

3000K/4000K

LED integrated

voltage: 48 V

LED 12W 720 lm 3000K

LED

IP20

LED 12W 780 lm 4000K

technical

installation: GAMMA Track Magnetic 5mm

specification

beam angle: 24°



COLOUR / NEW INDEX NO.

- 3000K BLACK (BK) . . . . . **AZ5287**
- 4000K BLACK (BK) . . . . . **AZ5288**

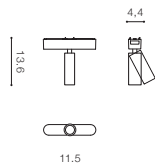

# GAMMA SANGRIA MILKY TRACK MAGNETIC 5MM

8 Track Magnetic System - GAMMA



BK

## GAMMA SANGRIA MILKY TRACK MAGN. 5MM 6W 3000K/4000K

LED integrated

voltage: 48 V

IP20

technical  
specification



LED 6W 360lm 3000K

LED 6W 420lm 4000K

installation: GAMMA Track Magnetic 5mm

beam angle: 120°



COLOUR / NEW INDEX NO.

- 3000K BLACK (BK) . . . . . **AZ5266**
- 4000K BLACK (BK) . . . . . **AZ5267**

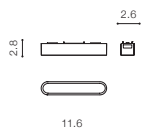

BK

## GAMMA SANGRIA MILKY TRACK MAGN. 5MM 12W 3000K/4000K

LED integrated

voltage: 48 V

IP20

technical  
specification



LED 12W 720lm 3000K

LED 12W 780lm 4000K

installation: GAMMA Track Magnetic 5mm

beam angle: 120°



COLOUR / NEW INDEX NO.

- 3000K BLACK (BK) . . . . . **AZ5269**
- 4000K BLACK (BK) . . . . . **AZ5270**

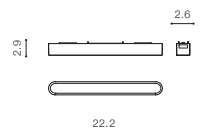

# GAMMA SANGRIA POINT TRACK MAGNETIC 5MM



BK

## GAMMA SANGRIA POINT TRACK MAGN. 5MM 6W 3000K/4000K

LED integrated

voltage: 48 V

LED 6W 360lm 3000K

LED

IP20

LED 6W 420lm 4000K

technical specification



installation: GAMMA Track Magnetic 5mm

beam angle: 24°

COLOUR / NEW INDEX NO.

- 3000K BLACK (BK) . . . . . **AZ5272**
- 4000K BLACK (BK) . . . . . **AZ5273**

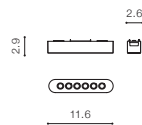

BK

## GAMMA SANGRIA POINT TRACK MAGN. 5MM 12W 3000K/4000K

LED integrated

voltage: 48 V

LED 12W 720lm 3000K

LED

IP20

LED 12W 780lm 4000K

technical specification



installation: GAMMA Track Magnetic 5mm

beam angle: 24°

COLOUR / NEW INDEX NO.

- 3000K BLACK (BK) . . . . . **AZ5275**
- 4000K BLACK (BK) . . . . . **AZ5276**

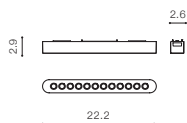

# GAMMA SANGRIA UGR TRACK MAGNETIC 5MM

10 Track Magnetic System - GAMMA



**GAMMA SANGRIA UGR TRACK MAGN. 5MM**  
**6W** 3000K/4000K LED integrated

voltage: 48 V	LED 6W 360lm 3000K	<b>LED</b>
IP20	LED 6W 420lm 4000K	
technical specification	installation: GAMMA Track Magnetic 5mm	<input checked="" type="checkbox"/>
	beam angle: 60°	<input checked="" type="checkbox"/>

COLOUR / NEW INDEX NO.

- 3000K BLACK (BK) . . . . . **AZ5278**
- 4000K BLACK (BK) . . . . . **AZ5279**

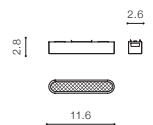

**GAMMA SANGRIA UGR TRACK MAGN. 5MM**  
**12W** 3000K/4000K LED integrated

voltage: 48 V	LED 12W 720lm 3000K	<b>LED</b>
IP20	LED 12W 780lm 4000K	
technical specification	installation: GAMMA Track Magnetic 5mm	<input checked="" type="checkbox"/>
	beam angle: 60°	<input checked="" type="checkbox"/>

COLOUR / NEW INDEX NO.

- 3000K BLACK (BK) . . . . . **AZ5281**
- 4000K BLACK (BK) . . . . . **AZ5282**

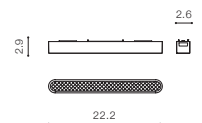

GAMMA SAGA TRACK MAGNETIC 5MM



BK

**GAMMA SAGA TRACK MAGNETIC 5MM 10W**  
3000K/4000K LED integrated

voltage: 48V	LED 10W 600lm 3000K	<b>LED</b>
IP20	LED 10W 660lm 4000K	
technical specification		installation: GAMMA Track Magnetic 5mm <input type="checkbox"/>
		beam angle: 120° <input type="checkbox"/>

COLOUR / NEW INDEX NO.

- 3000K BLACK (BK) . . . . . **AZ5298**
- 4000K BLACK (BK) . . . . . **AZ5299**

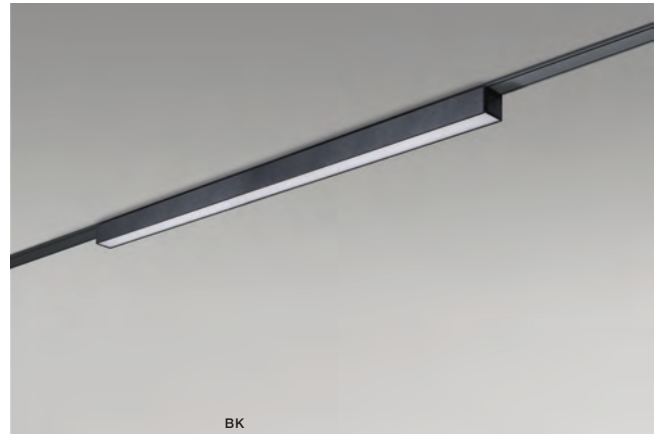

BK

**GAMMA SAGA TRACK MAGNETIC 5MM 20W**  
3000K/4000K LED integrated

voltage: 48V	LED 20W 1200lm 3000K	<b>LED</b>
IP20	LED 20W 1260lm 4000K	
technical specification		installation: GAMMA Track Magnetic 5mm <input type="checkbox"/>
		beam angle: 120° <input type="checkbox"/>

COLOUR / NEW INDEX NO.

- 3000K BLACK (BK) . . . . . **AZ5301**
- 4000K BLACK (BK) . . . . . **AZ5302**

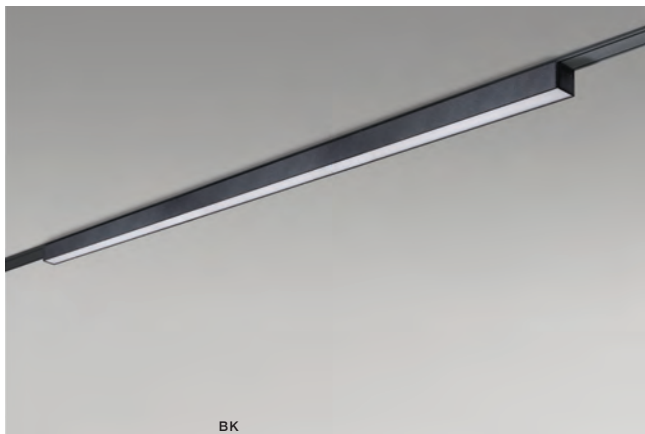
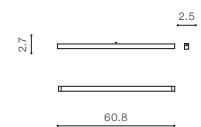

BK

**GAMMA SAGA TRACK MAGNETIC 5MM 30W**  
3000K/4000K LED integrated

voltage: 48V	LED 30W 1800lm 3000K	<b>LED</b>
IP20	LED 30W 1860lm 4000K	
technical specification		installation: GAMMA Track Magnetic 5mm <input type="checkbox"/>
		beam angle: 120° <input type="checkbox"/>

COLOUR / NEW INDEX NO.

- 3000K BLACK (BK) . . . . . **AZ5304**
- 4000K BLACK (BK) . . . . . **AZ5305**

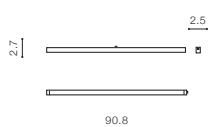

# GAMMA DANKA TRACK MAGNETIC 5MM

12 Track Magnetic System - GAMMA



BK

## GAMMA DANKA TRACK MAGNETIC 5MM 8W 3000K/4000K LED integrated

voltage: 48V	LED 8W 630lm 3000K	<b>LED</b>
IP20	LED 8W 660lm 4000K	
technical specification		installation: GAMMA Track Magnetic 5mm <input type="checkbox"/>
		beam angle: 120° <input checked="" type="checkbox"/>

### COLOUR / NEW INDEX NO.

- 3000K BLACK (BK) . . . . . **AZ5306**
- 4000K BLACK (BK) . . . . . **AZ5307**

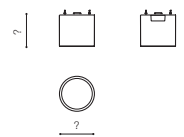

GAMMA DANIEL TRACK MAGNETIC 5MM



BK

**GAMMA DANIEL TRACK MAGNETIC 5MM 8W**  
3000K/4000K LED integrated

voltage: 48V	LED 8W 440lm 3000K	<b>LED</b>
IP20	LED 8W 460lm 4000K	
technical	installation: GAMMA Track Magnetic 5mm	<input type="checkbox"/>
specification	beam angle: 120°	<input checked="" type="checkbox"/>



COLOUR / NEW INDEX NO.

- 3000K BLACK (BK) . . . . . **AZ5308**
- 4000K BLACK (BK) . . . . . **AZ5309**

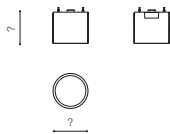

# REMOTE CONTROL BLUETOOTH

## Remote Control 4-Group & RGB & Bluetooth Operating Schematic

AZ5265

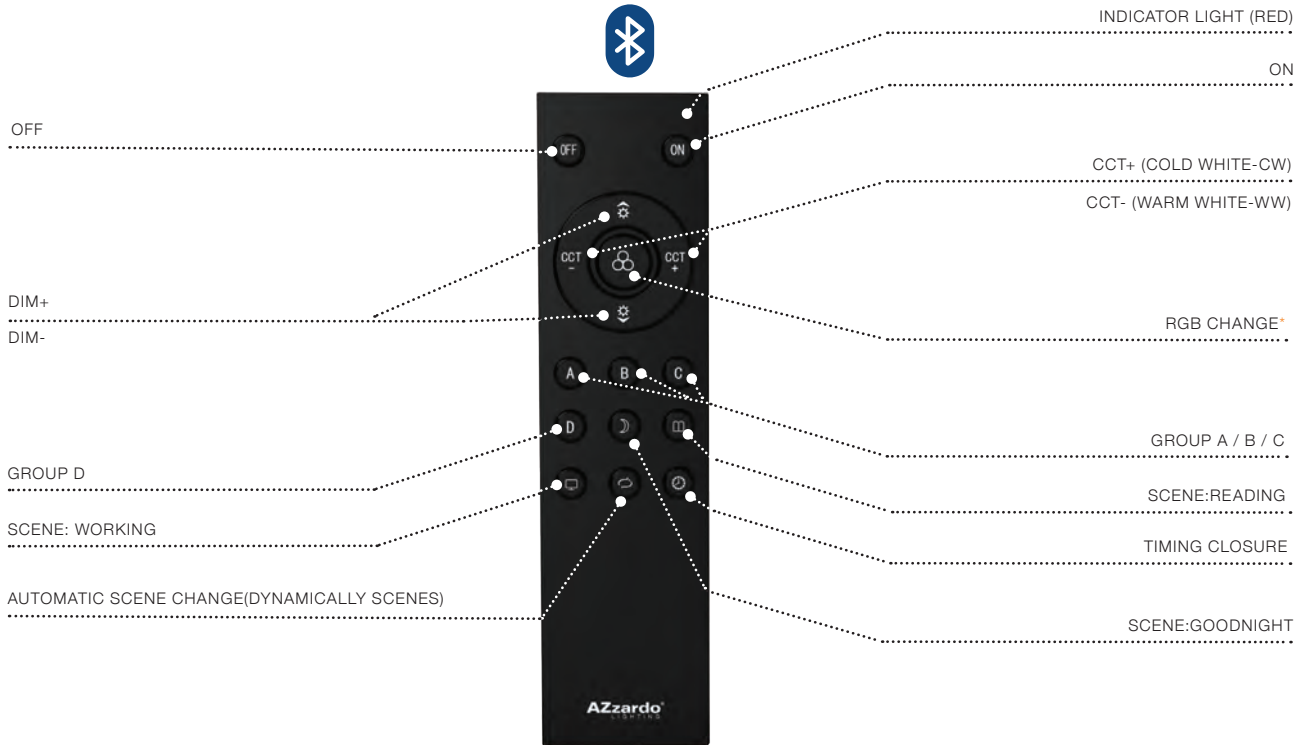

\*RGB CHANGE ONLY USED FOR RGB LAMPS  
THE CCT LAMP CAN'T BE USE THIS BUTTON FUNCTION

## Remote Control 3 Group Operating Schematic

AZ4857

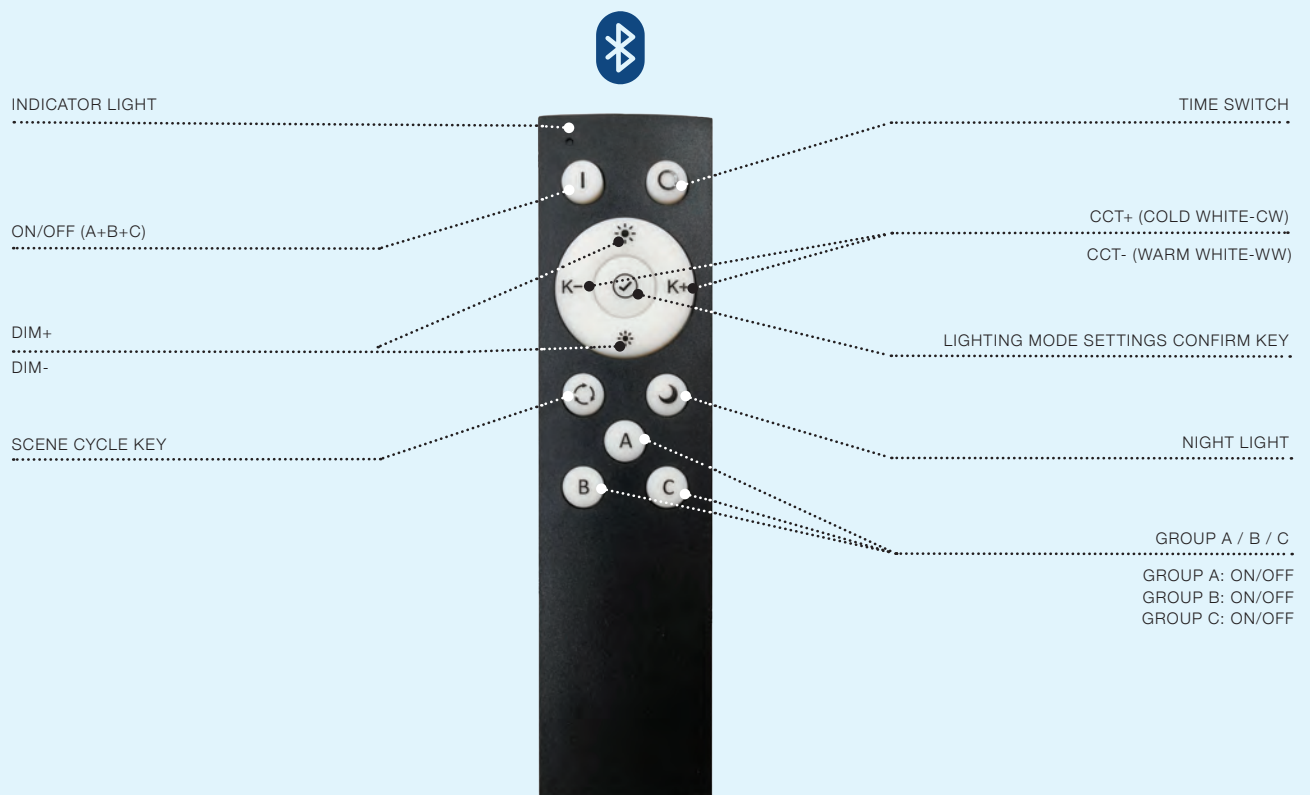



Switch Panel Remote Control 2-Group Bluetooth Bk

Operating Schematic

AZ5209

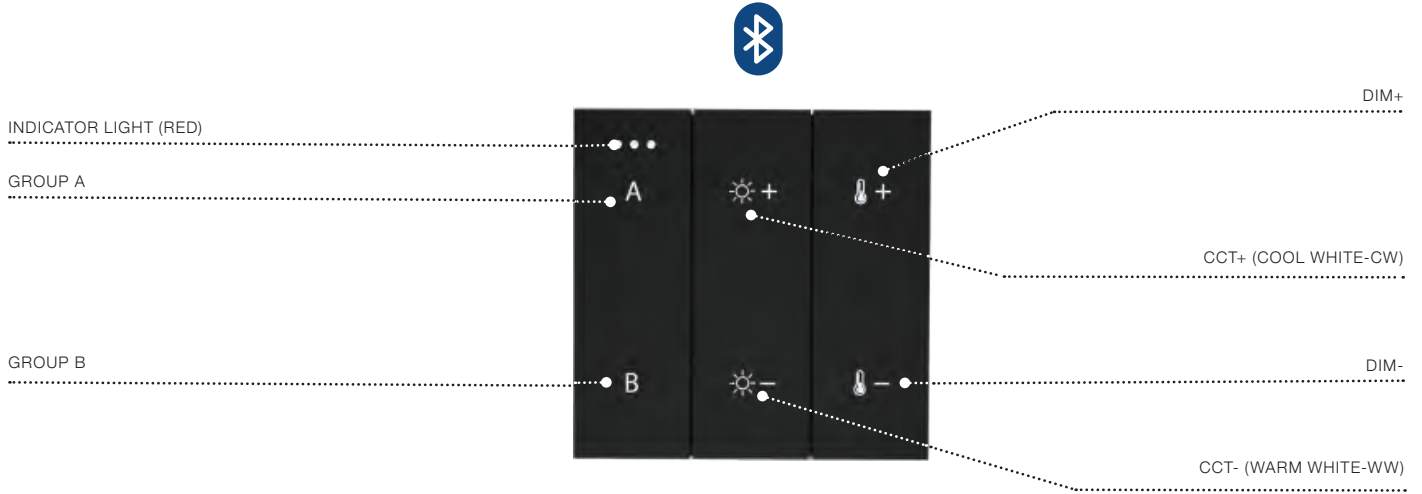

Switch Panel Remote Control 2-Group Bluetooth

SWITCH PANEL REMOTE CONTROL 2-GROUP BLUETOOTH (WH) . . . . . AZ5210

DOWNLOAD THE APP



STANDARD

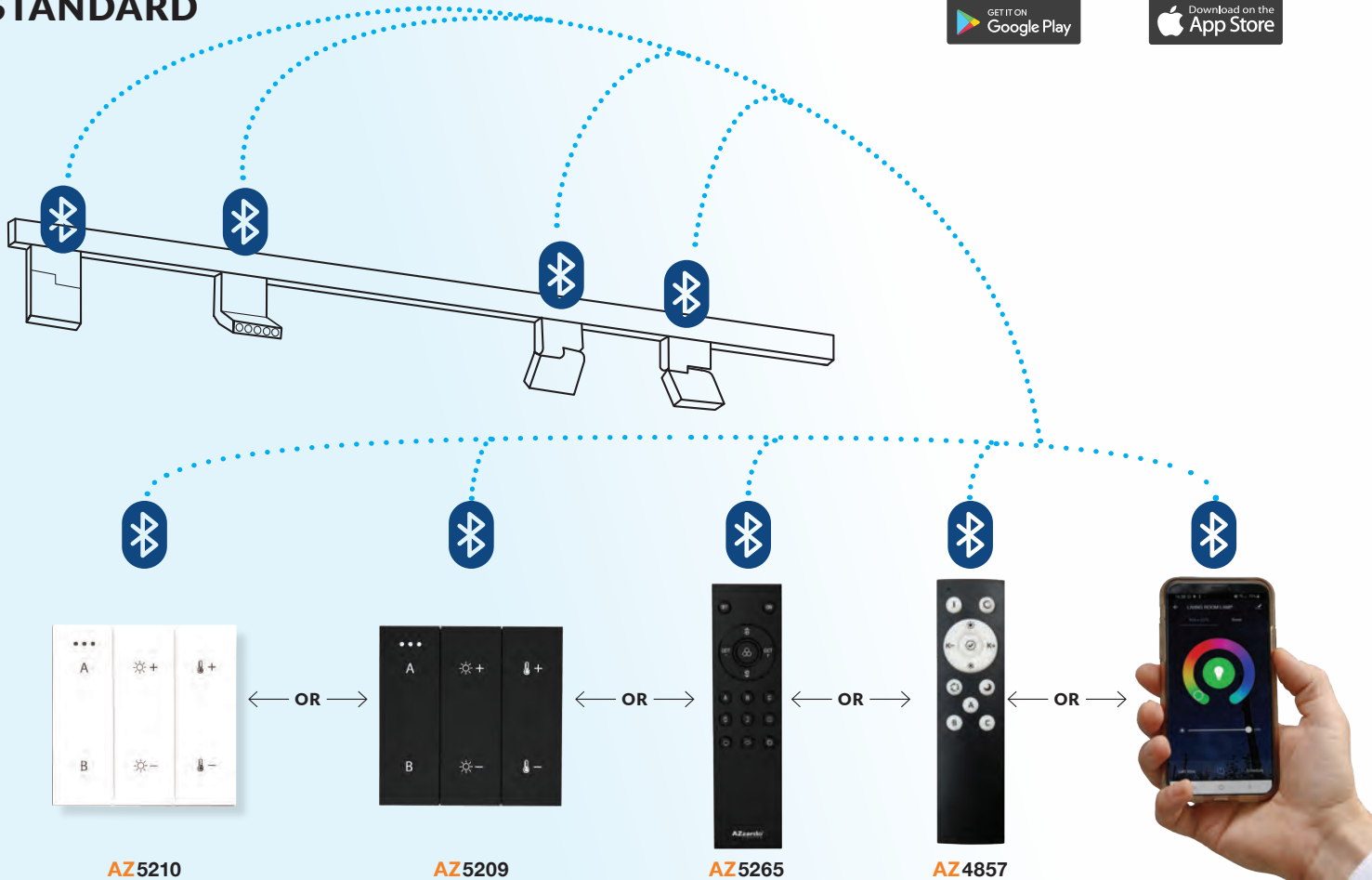

# GAMMA KIRA TRACK MAGNETIC 5MM CCT BLUETOOTH

16 Track Magnetic System - GAMMA



**GAMMA KIRA TRACK MAGNETIC 5MM 12W**  
CCT BLUETOOTH LED integrated

voltage: 48V	LED 12W 880 lm CCT 2700-6000K	<b>LED</b>
IP20	dimmable	
technical specification	installation: GAMMA Track Magnetic 5mm	
	beam angle: 24°	

**GAMMA KIRA TRACK MAGNETIC 5MM 18W**  
CCT BLUETOOTH LED integrated

voltage: 48V	LED 12W 840 lm CCT 2700-6000K	<b>LED</b>
IP20	dimmable	
technical specification	installation: GAMMA Track Magnetic 5mm	
	beam angle: 24°	

COLOUR / NEW INDEX NO.

■ BLACK (BK) . . . . . **AZ5292** 2.5

22

COLOUR / NEW INDEX NO.

■ BLACK (BK) . . . . . **AZ5295** 2.5

32.8

# GAMMA NIKO TRACK MAGNETIC 5MM CCT BLUETOOTH



**GAMMA NIKO TRACK MAGNETIC 5MM 7W**  
CCT BLUETOOTH LED integrated

voltage: 48 V	LED 7W 480 lm CCT 2700-6000K	<b>LED</b>
IP20	dimmable	
technical specification	installation: GAMMA Track Magnetic 5mm	<input type="checkbox"/>
	beam angle: 24°	<input type="checkbox"/>

COLOUR / NEW INDEX NO.

■ BLACK (BK) . . . . . **AZ5286**

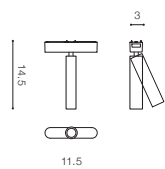

**GAMMA NIKO TRACK MAGNETIC 5MM 12W**  
CCT BLUETOOTH LED integrated

voltage: 48 V	LED 12W 780lm CCT 2700-6000K	<b>LED</b>
IP20	dimmable	
technical specification	installation: GAMMA Track Magnetic 5mm	<input type="checkbox"/>
	beam angle: 24°	<input type="checkbox"/>

COLOUR / NEW INDEX NO.

■ BLACK (BK) . . . . . **AZ5289**

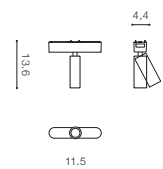

# GAMMA SANGRIA MILKY TRACK MAGN. 5MM CCT BLUETOOTH

18 Track Magnetic System - GAMMA



## GAMMA SANGRIA MILKY TRACK MAGN. 6W CCT BLUETOOTH LED integrated

voltage: 48 V	LED 6W 420 lm CCT 2700-6000K		<b>LED</b>
IP20	dimnable		
technical specification	installation: GAMMA Track Magnetic 5mm	<input type="checkbox"/>	<input type="checkbox"/>
	beam angle: 120°	<input type="checkbox"/>	<input type="checkbox"/>

COLOUR / NEW INDEX NO. 2.6

BLACK (BK) . . . . . **AZ5268** 2.6

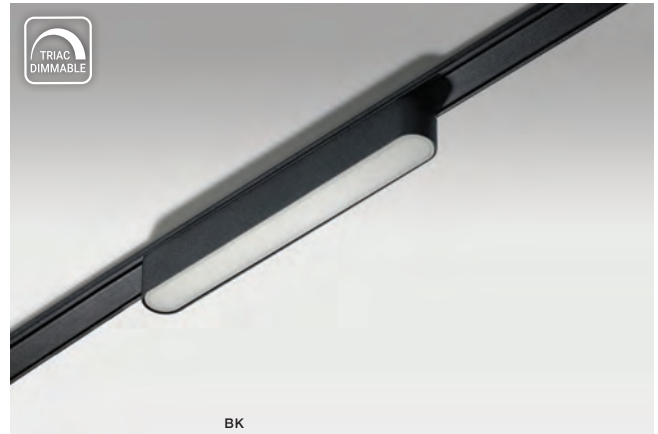
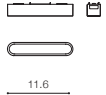

## GAMMA SANGRIA MILKY TRACK MAGN. 5MM 12W CCT BLUETOOTH LED integrated

voltage: 48 V	LED 12W 780lm CCT 2700-6000K		<b>LED</b>
IP20	dimnable		
technical specification	installation: GAMMA Track Magnetic 5mm	<input type="checkbox"/>	<input type="checkbox"/>
	beam angle: 120°	<input type="checkbox"/>	<input type="checkbox"/>

COLOUR / NEW INDEX NO. 2.6

BLACK (BK) . . . . . **AZ5271** 2.6



GAMMA SANGRIA POINT TRACK MAGN. 5MM CCT BLUETOOTH



BK

**GAMMA SANGRIA POINT TRACK MAGN. 5MM 6W**  
CCT BLUETOOTH LED integrated

voltage: 48 V	LED 6W 420 lm CCT 2700-6000K	<b>LED</b>
IP20	dimnable	
technical specification	installation: GAMMA Track Magnetic 5mm	<input type="checkbox"/>
	beam angle: 24°	<input checked="" type="checkbox"/>

COLOUR / NEW INDEX NO.

■ BLACK (BK) . . . . . **AZ5274**

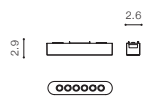

BK

**GAMMA SANGRIA POINT TRACK MAGN. 5MM 12W**  
CCT BLUETOOTH LED integrated

voltage: 48 V	LED 12W 780lm CCT 2700-6000K	<b>LED</b>
IP20	dimnable	
technical specification	installation: GAMMA Track Magnetic 5mm	<input type="checkbox"/>
	beam angle: 24°	<input checked="" type="checkbox"/>

COLOUR / NEW INDEX NO.

■ BLACK (BK) . . . . . **AZ5277**

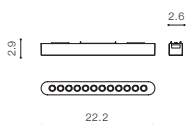

# GAMMA SANGRIA UGR TRACK MAGNETIC 5MM CCT BLUETOOTH

20 Track Magnetic System - GAMMA



BK

## GAMMA SANGRIA UGR TRACK MAGN. 5MM 6W CCT BLUETOOTH

LED integrated

voltage: 48 V	LED 6W 420 lm CCT 2700-6000K	<b>LED</b>
IP20	dimnable	
technical specification	installation: GAMMA Track Magnetic 5mm	<input type="checkbox"/>
	beam angle: 60°	<input checked="" type="checkbox"/>



COLOUR / NEW INDEX NO.

■ BLACK (BK) . . . . . **AZ5280**

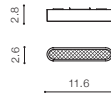

BK

## GAMMA SANGRIA UGR TRACK MAGN. 5MM 12W CCT BLUETOOTH

LED integrated

voltage: 48 V	LED 12W 780lm CCT 2700-6000K	<b>LED</b>
IP20	dimnable	
technical specification	installation: GAMMA Track Magnetic 5mm	<input type="checkbox"/>
	beam angle: 60°	<input checked="" type="checkbox"/>



COLOUR / NEW INDEX NO.

■ BLACK (BK) . . . . . **AZ5283**

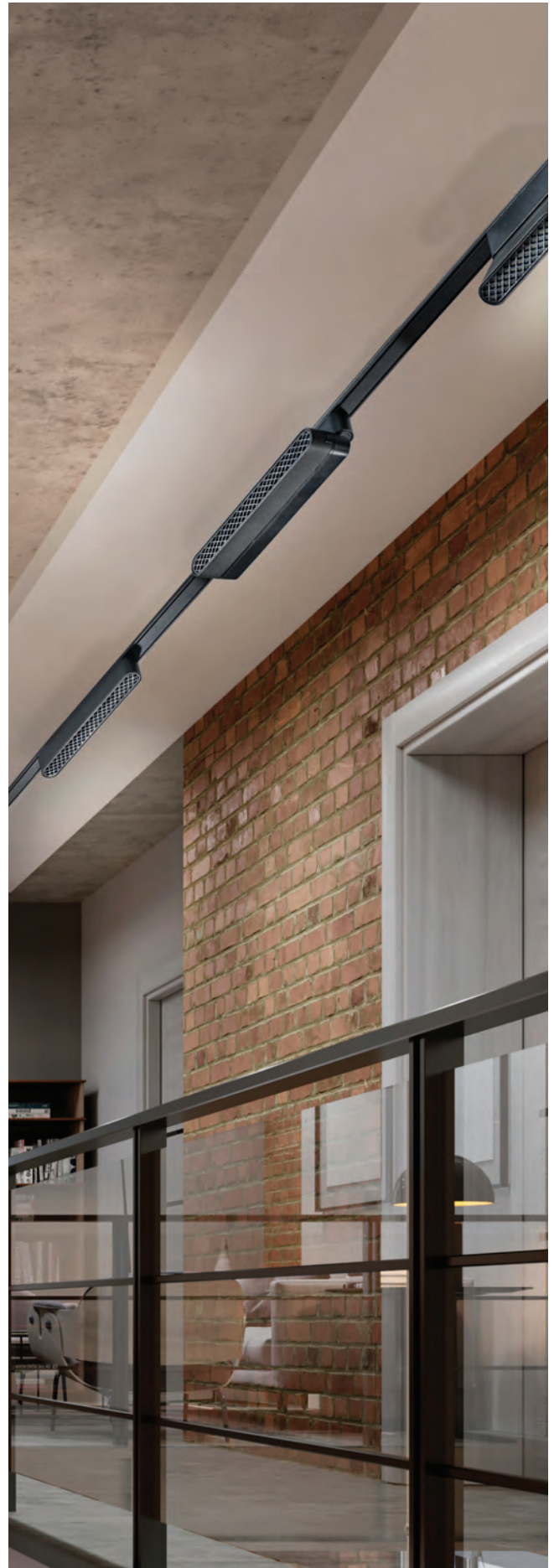
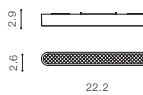

# GAMMA SAGA TRACK MAGNETIC 5MM CCT BLUETOOTH



## GAMMA SAGA TRACK MAGNETIC 5MM 10W CCT BLUETOOTH LED integrated

voltage: 48 V	LED 10W 1060lm CCT 2700-6000K	<b>LED</b>
IP20	dimmable	
technical specification		installation: GAMMA Track Magnetic 5mm <input type="checkbox"/>
		beam angle: 120° <input type="checkbox"/>

COLOUR / NEW INDEX NO.



<input checked="" type="checkbox"/> BLACK (BK) . . . . . <b>AZ5300</b>	2.5	
		



## GAMMA SAGA TRACK MAGNETIC 5MM 20W CCT BLUETOOTH LED integrated

voltage: 48 V	LED 20W 1860lm CCT 2700-6000K	<b>LED</b>
IP20	dimmable	
technical specification		installation: GAMMA Track Magnetic 5mm <input type="checkbox"/>
		beam angle: 120° <input type="checkbox"/>

COLOUR / NEW INDEX NO.

<input checked="" type="checkbox"/> BLACK (BK) . . . . . <b>AZ5303</b>	2.7	
		



# GAMMA SAGA TRACK MAGNETIC 5MM CCT BLUETOOTH

22 Track Magnetic System - GAMMA

# Adaptable



ADAPTER SMALL

TILT IS POSSIBLE ONLY WITH ADAPTER

TILT 90°



ONLY LAMP



ADAPTER SMALL + LAMP



ONLY LAMP



ADAPTER SMALL + LAMP



ONLY LAMP



ADAPTER SMALL + LAMP



# GAMMA SAGA TRACK MAGNETIC 5MM CCT BLUETOOTH

Track Magnetic System – GAMMA

ers

ADAPTER BIG

TILT IS POSSIBLE ONLY WITH ADAPTER

TILT 90°



SYSTEM COMPONENTS NAMES FOR TRACK MAGNETIC SYSTEM - BETA

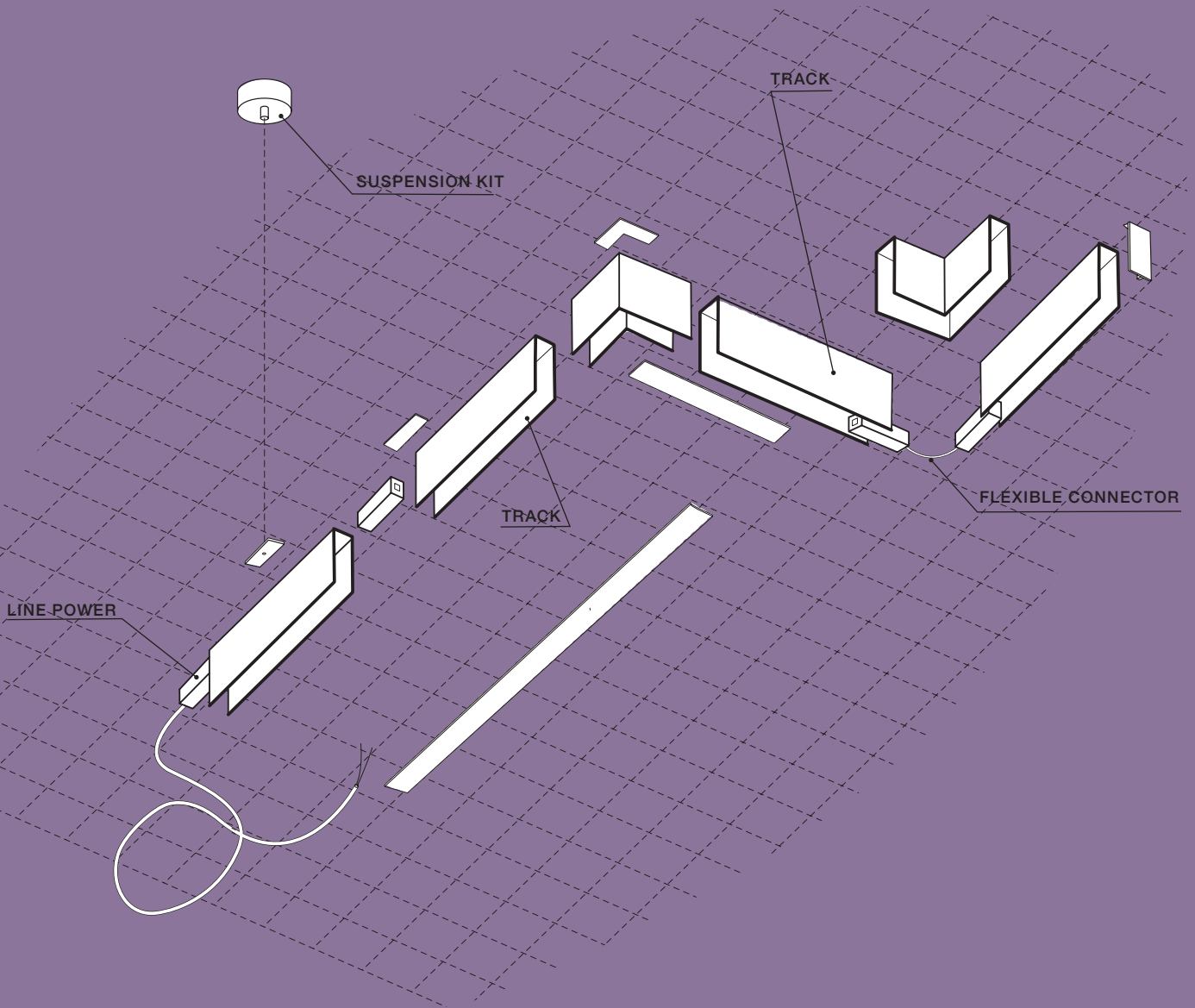

**BETA**  
TRACK MAGNETIC

# BETA

track Magnetic

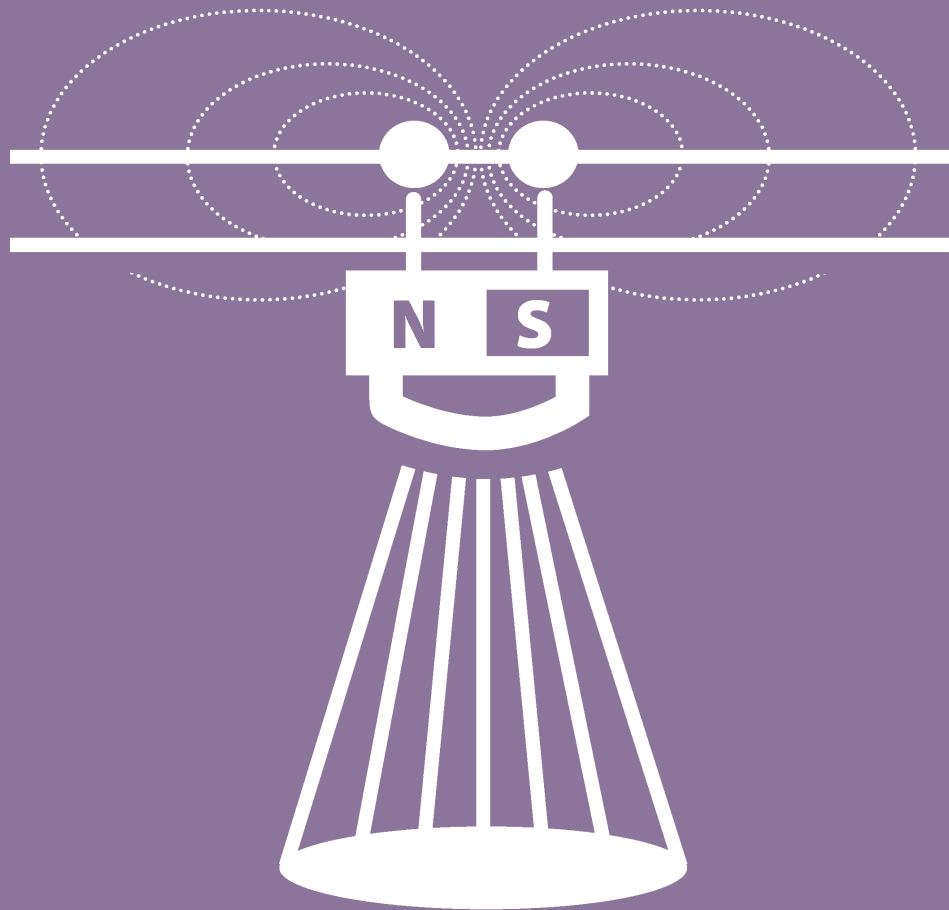

# BETA TRACK MAGNETIC57 230V

26 Components for BETA Track Magnetic

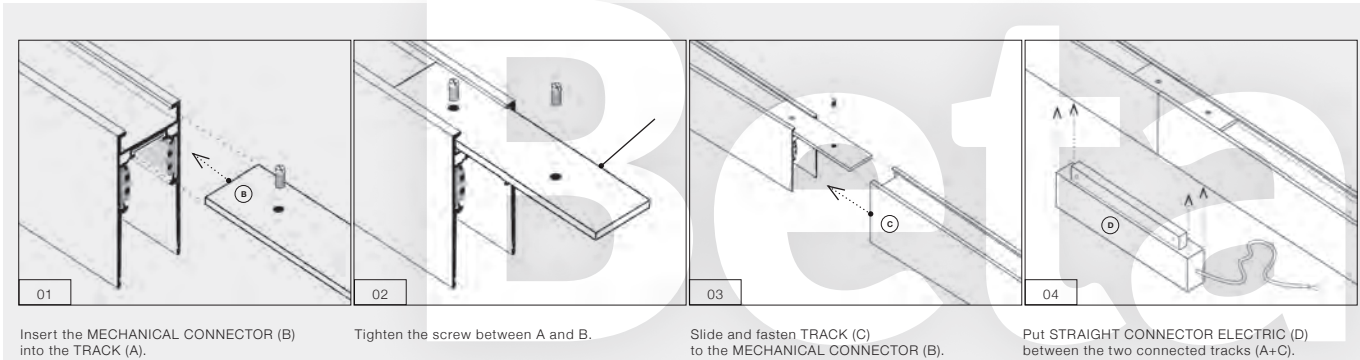

## Example of the connection between track

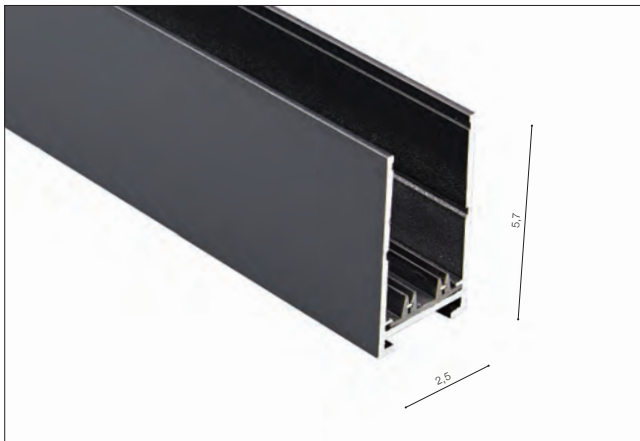
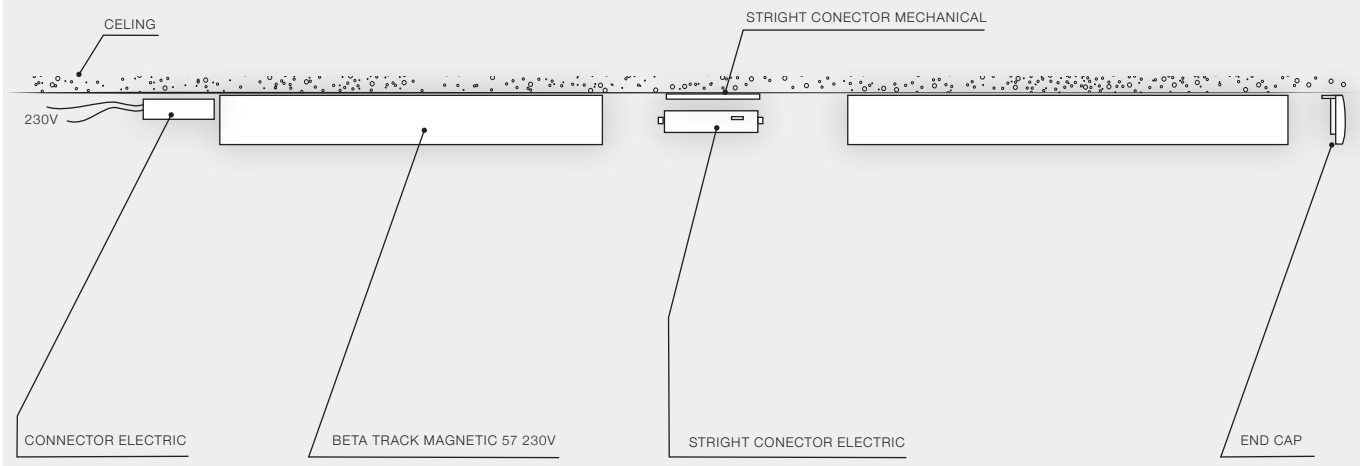

### BETA TRACK MAGNETIC57 230V (1M, 2M, 3M)

- BETA TRACK MAGNETIC57 230V 1M (BLACK) . . . . . **AZ5139**
- BETA TRACK MAGNETIC57 230V 1M (WHITE) . . . . . **AZ5140**
- BETA TRACK MAGNETIC57 230V 2M (BLACK) . . . . . **AZ5241**
- BETA TRACK MAGNETIC57 230V 2M (WHITE) . . . . . **AZ5242**
- BETA TRACK MAGNETIC57 230V 3M (BLACK) . . . . . **AZ5143**
- TRACK MAGNETIC57 230V 3M (WHITE) . . . . . **AZ5144**

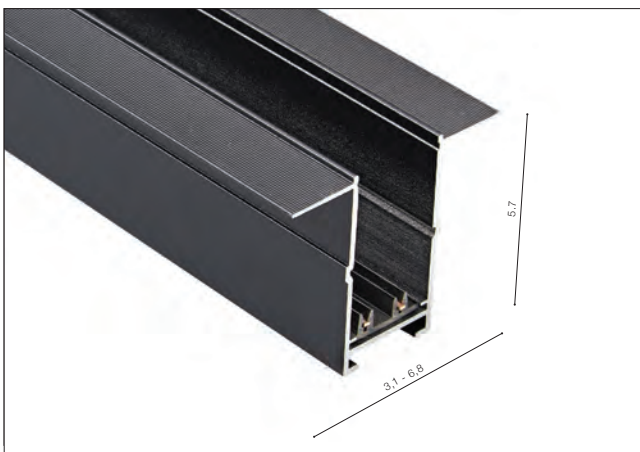

### BETA TRACK MAGNETIC57 230V GIPS1 (1M, 2M, 3M)

- BETA TRACK MAGNETIC57 230V GIPS1 1M (BLACK) . . . . . **AZ5145**
- BETA TRACK MAGNETIC57 230V GIPS1 1M (WHITE) . . . . . **AZ5146**
- BETA TRACK MAGNETIC57 230V GIPS1 2M (BLACK) . . . . . **AZ5147**
- BETA TRACK MAGNETIC57 230V GIPS1 2M (WHITE) . . . . . **AZ5148**
- BETA TRACK MAGNETIC57 230V GIPS1 3M (BLACK) . . . . . **AZ5149**
- BETA TRACK MAGNETIC57 230V GIPS1 3M (WHITE) . . . . . **AZ5150**

Available options for installation place – surface-mounted, flush-mounted and suspended

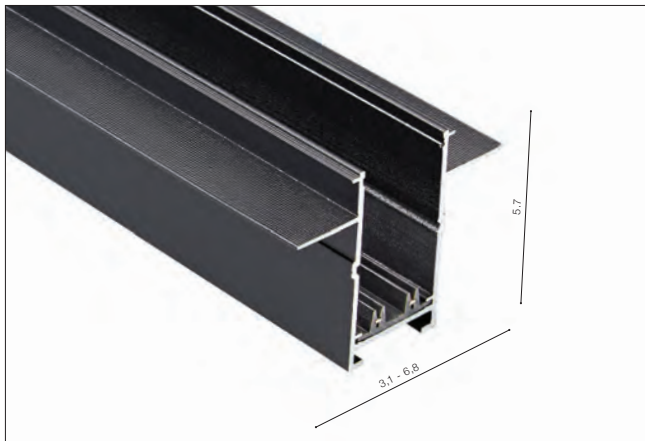
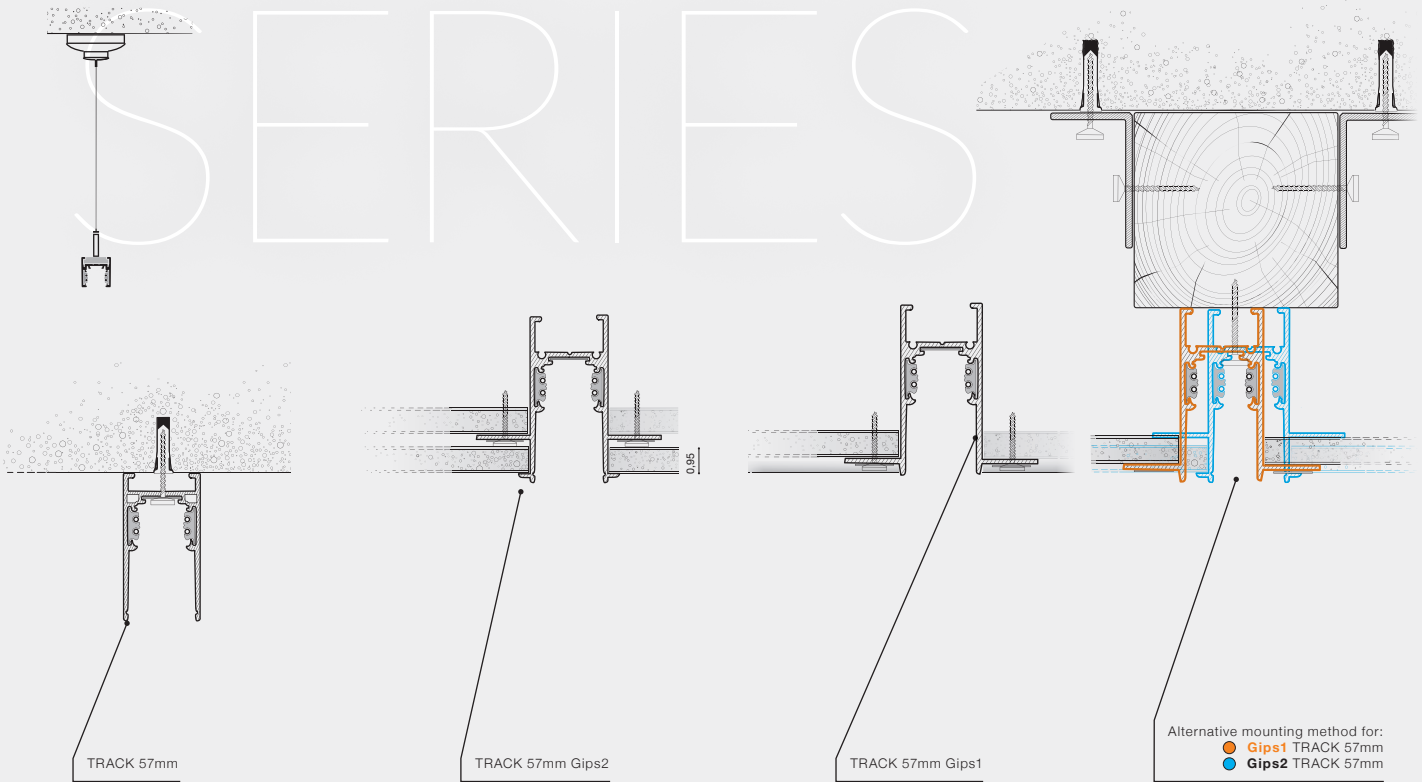

**BETA TRACK MAGNETIC57 230V GIPS2 (1M, 2M, 3M)**

- BETA TRACK MAGNETIC57 230V GIPS2 1M (BLACK) . . . . . **AZ5170**
- BETA TRACK MAGNETIC57 230V GIPS2 2M (BLACK) . . . . . **AZ5171**
- BETA TRACK MAGNETIC57 230V GIPS2 3M (BLACK) . . . . . **AZ5172**

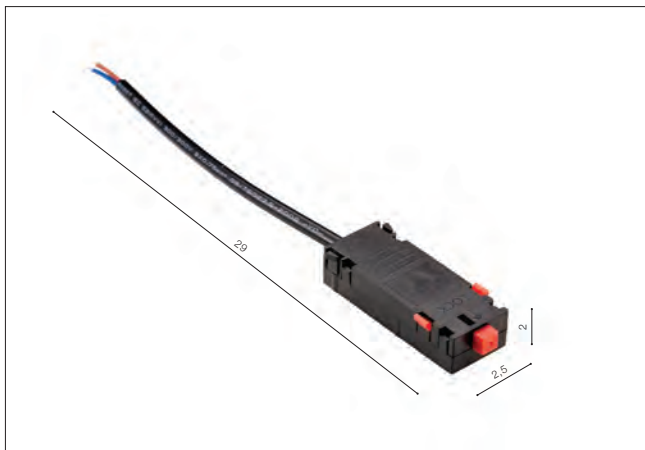

**BETA TRACK MAGNETIC57 230V CONNECTOR ELECTRIC**

- BETA TRACK MAGNETIC57 230V CONNECTOR (BLACK) . . . . . **AZ5154**

# BETA TRACK MAGNETIC57 230V

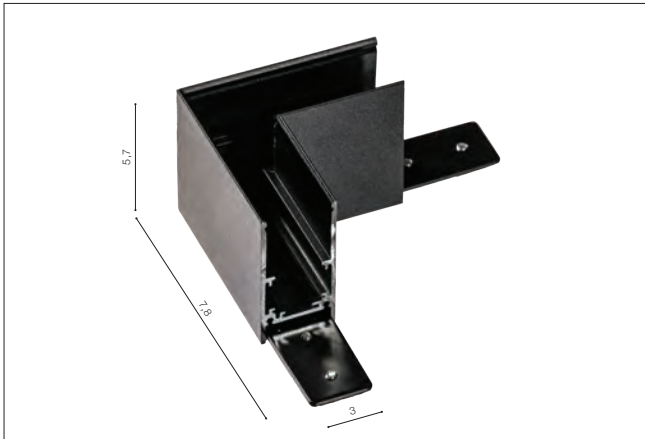

## BETA TRACK MAGNETIC57 230V CORNER90 A

- BETA TRACK MAGNETIC57 230V CORNER90 A (BLACK) . . . . . **AZ5158**
- BETA TRACK MAGNETIC57 230V CORNER90 A (WHITE) . . . . . **AZ5159**

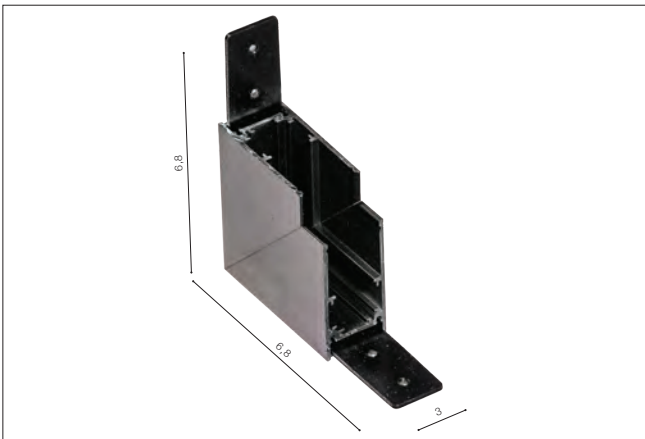

## BETA TRACK MAGNETIC57 230V CORNER90 B

- BETA TRACK MAGNETIC57 230V INNER CORNER90 B (BLACK) . . . . . **AZ5160**
- BETA TRACK MAGNETIC57 230V INNER CORNER90 B (WHITE) . . . . . **AZ5161**

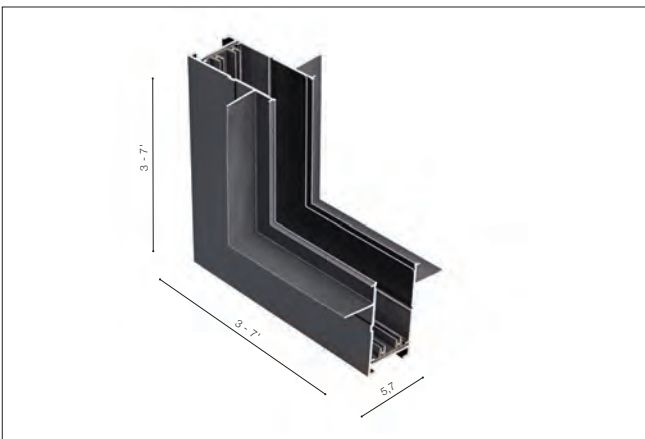

## BETA TRACK MAGNETIC57 230V CORNER90 B GIPS1

- BETA TRACK MAGNETIC57 230V CORNER90 B GIPS1 (BLACK) . . . . . **AZ5164**
- BETA TRACK MAGNETIC57 230V CORNER90 B GIPS1 (WHITE) . . . . . **AZ5165**

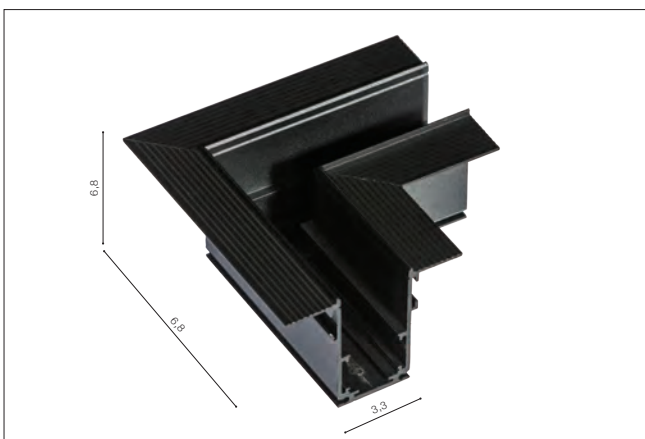

## BETA TRACK MAGNETIC57 230V CORNER90 A GIPS1

- BETA TRACK MAGNETIC57 230V CORNER90 A GIPS1 (BLACK) . . . . . **AZ5162**
- BETA TRACK MAGNETIC57 230V CORNER90 A GIPS1 (WHITE) . . . . . **AZ5163**



**BETA TRACK MAGNETIC57 230V  
CORNER90 B GIPS2**

■ BETA Track Magnetic57 230V Corner90 B Gips2 (black) . . . . . **AZ5174**

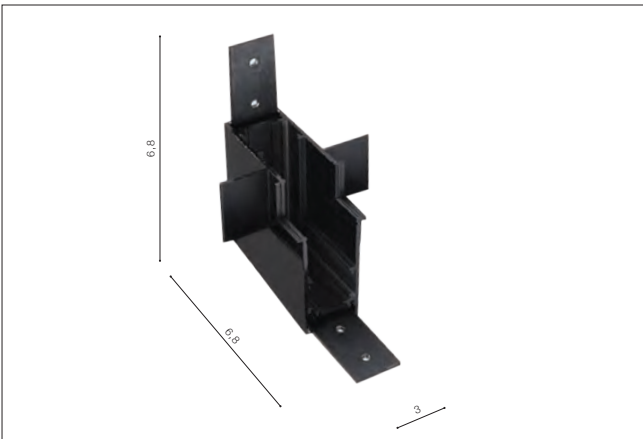

**BETA TRACK MAGNETIC57 230V  
CORNER90 A GIPS2**

■ BETA TRACK MAGNETIC57 230V CORNER90 A GIPS2 (BLACK) . . . . . **AZ5173**



**BETA TRACK MAGNETIC57 230V  
FLEX CONNECTOR ELECTRIC**

■ BETA TRACK MAGNETIC57 230V FLEX CONNECTOR ELECTRIC (BLACK) . . . **AZ5153**

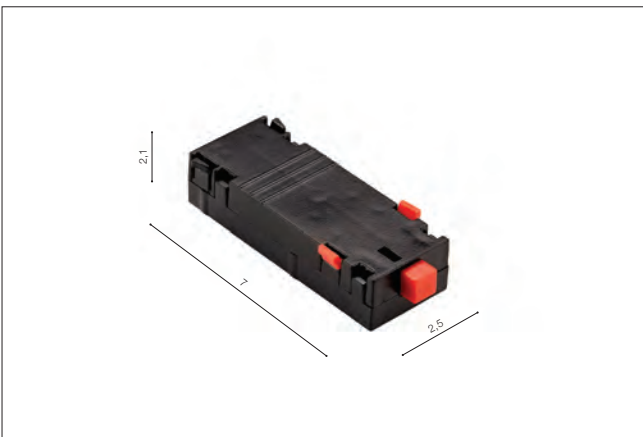

**BETA TRACK MAGNETIC57 230V  
STRAIGHT CONNECTOR ELECTRIC**

■ BETA TRACK MAGNETIC57 230V STRAIGHT CONNECTOR ELECTRIC (BLACK) **AZ5152**

# BETA TRACK MAGNETIC57 230V



## BETA TRACK MAGNETIC57 230V STRAIGHT CONNECTOR MECHANICAL

- BETA TRACK MAGNETIC57 230V STRAIGHT CONNECTOR MECHANICAL (BLACK) **AZ5151**



## BETA TRACK MAGNETIC57 230V SUSPENSION KIT

- BETA TRACK MAGNETIC57 230V SUSPENSION KIT (BLACK) . . . . . **AZ5155**

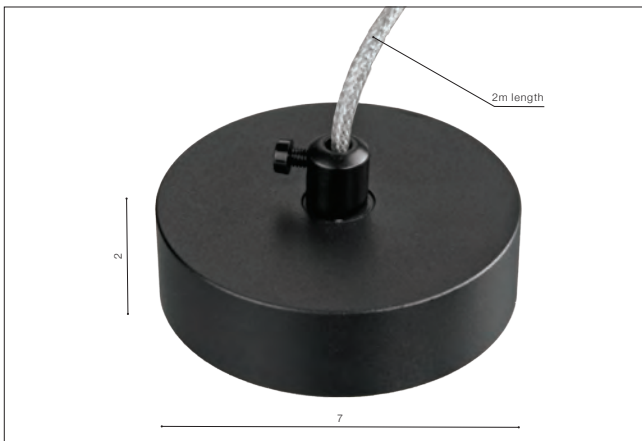

## Ceiling Plate + Wire

- TRACK CEILING PLATE + WIRE (BLACK) . . . . . **AZ4780**
- TRACK CEILING PLATE + WIRE (WHITE) . . . . . **AZ4782**

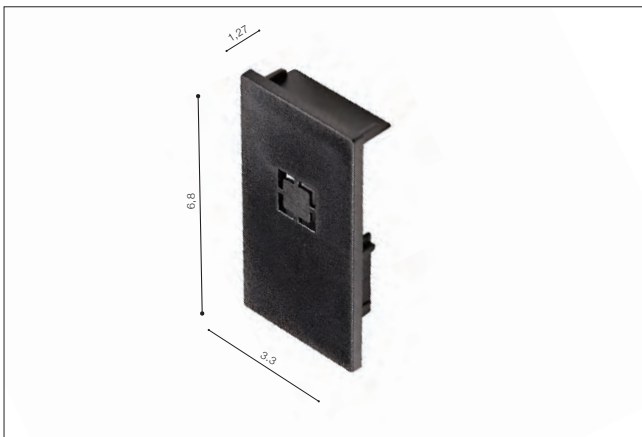

## BETA TRACK MAGNETIC57 230V END CAP

- BETA TRACK MAGNETIC57 230V END CAP (BLACK) . . . . . **AZ5166**
- BETA TRACK MAGNETIC57 230V END CAP (WHITE). . . . . **AZ5167**



# BETA TRACK MAGNETIC57 230V

Accessories for BETA Track Magnetic



## BETA TRACK MAGNETIC57 230V COVER

- BETA TRACK MAGNETIC57 230V COVER (BLACK) . . . . . **AZ5168**
- BETA TRACK MAGNETIC57 230V COVER (WHITE) . . . . . **AZ5169**

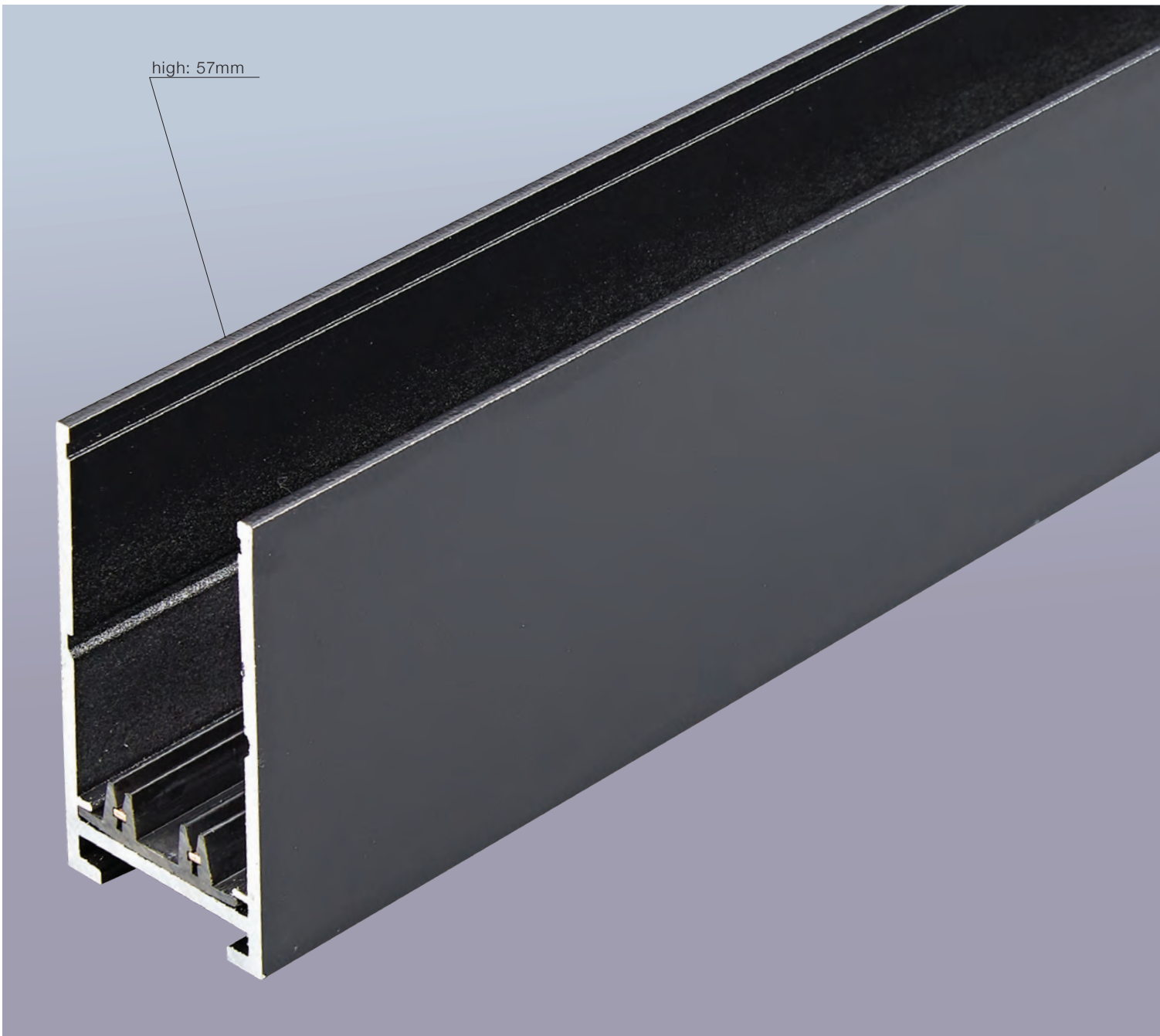

# BETA KIRA 230V TRACK MAGNETIC57

32 Track Magnetic System - BETA

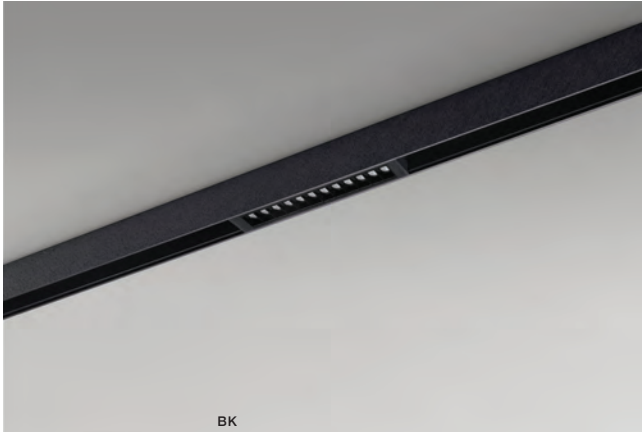

## BETA KIRA 230V TRACK MAGNETIC 9W 3000K/4000K LED integrated

voltage: 230V	LED 9W 685lm 3000K dimmable	<b>LED</b>
IP20	LED 9W 726lm 4000K dimmable	
technical specification	installation: BETA Track Magnetic 230V	<input type="checkbox"/>
	beam angle: 24°	<input type="checkbox"/>

COLOUR / NEW INDEX NO.

- 3000K BLACK (BK) . . . . . **AZ5187**
- 4000K BLACK (BK) . . . . . **AZ5211**

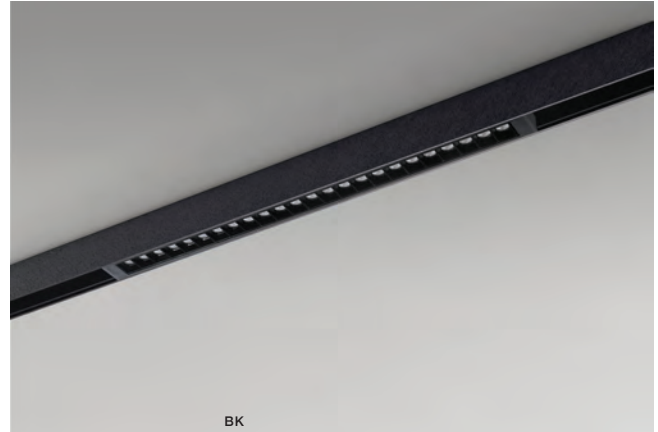
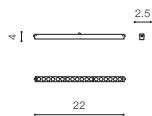

## BETA KIRA 230V TRACK MAGNETIC 18W 3000K/4000K LED integrated

voltage: 230V	LED 18W 1300lm 3000K dimmable	<b>LED</b>
IP20	LED 18W 1346lm 4000K dimmable	
technical specification	installation: BETA Track Magnetic 230V	<input type="checkbox"/>
	beam angle: 24°	<input type="checkbox"/>

COLOUR / NEW INDEX NO.

- 3000K BLACK (BK) . . . . . **AZ5188**
- 4000K BLACK (BK) . . . . . **AZ5212**

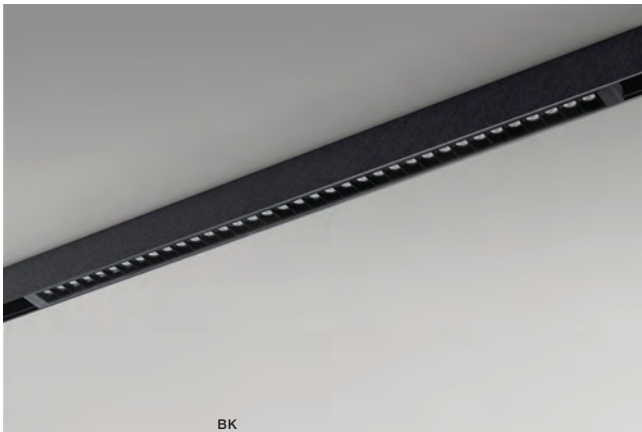
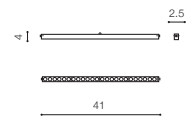

## BETA KIRA 230V TRACK MAGNETIC 27W 3000K/4000K LED integrated

voltage: 230V	LED 27W 1357lm 3000K dimmable	<b>LED</b>
IP20	LED 27W 1416lm 4000K dimmable	
technical specification	installation: BETA Track Magnetic 230V	<input type="checkbox"/>
	beam angle: 24°	<input type="checkbox"/>

COLOUR / NEW INDEX NO.

- 3000K BLACK (BK) . . . . . **AZ5189**
- 4000K BLACK (BK) . . . . . **AZ5213**

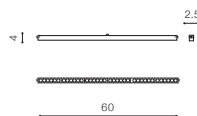

## BETA KIRA 230V TRACK MAGNETIC57

Track Magnetic System - BETA 33



# BETA SAGA 230V TRACK MAGNETIC57

34 Track Magnetic System - BETA



BK

## BETA SAGA 230V TRACK MAGNETIC 9W 3000K/4000K LED integrated

voltage: 230V	LED 9W 495lm 3000K dimmable	<b>LED</b>
IP20	LED 9W 524lm 4000K dimmable	
technical specification	installation: BETA Track Magnetic 230V	<input type="checkbox"/>
	beam angle: 120°	<input type="checkbox"/>

COLOUR / NEW INDEX NO.

- 3000K BLACK (BK) . . . . . **AZ5190** 4 |
- 4000K BLACK (BK) . . . . . **AZ5214** 2,5 |   
22



BK

## BETA SAGA 230V TRACK MAGNETIC 18W 3000K/4000K LED integrated

voltage: 230V	LED 18W 603lm 3000K dimmable	<b>LED</b>
IP20	LED 18W 1097lm 4000K dimmable	
technical specification	installation: BETA Track Magnetic 230V	<input type="checkbox"/>
	beam angle: 120°	<input type="checkbox"/>

COLOUR / NEW INDEX NO.

- 3000K BLACK (BK) . . . . . **AZ5191** 4 |
- 4000K BLACK (BK) . . . . . **AZ5215** 2,5 |   
41

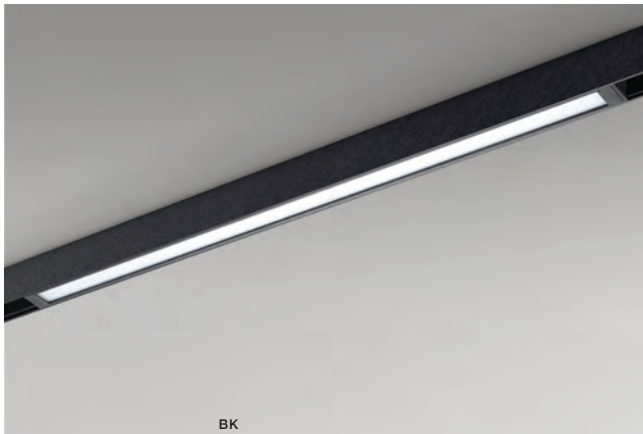

BK

## BETA SAGA 230V TRACK MAGNETIC 27W 3000K/4000K LED integrated

voltage: 230V	LED 27W 947lm 3000K dimmable	<b>LED</b>
IP20	LED 27W 1215lm 4000K dimmable	
technical specification	installation: BETA Track Magnetic 230V	<input type="checkbox"/>
	beam angle: 120°	<input type="checkbox"/>

COLOUR / NEW INDEX NO.

- 3000K BLACK (BK) . . . . . **AZ5192** 4 |
- 4000K BLACK (BK) . . . . . **AZ5216** 2,5 |   
60

## BETA SAGA 230V TRACK MAGNETIC57

Track Magnetic System - BETA 35



# BETA SANDERS 230V TRACK MAGNETIC57

36 Track Magnetic System - BETA

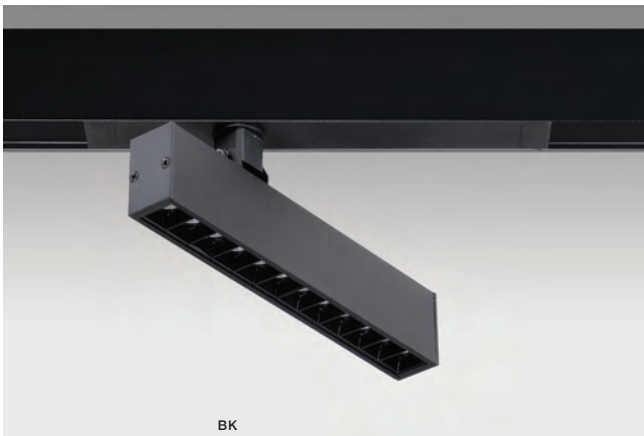

BK

## BETA SANDERS 230V TRACK MAGNETIC 9W

3000K/4000K

LED integrated

voltage: 230V

LED 9W 666lm 3000K dimmable

LED

IP20

LED 9W 700lm 4000K dimmable

technical

installation: BETA Track Magnetic 230V

specification

beam angle: 24°



COLOUR / NEW INDEX NO.

■ 3000K BLACK (BK) . . . . . **AZ5193**

■ 4000K BLACK (BK) . . . . . **AZ5194**

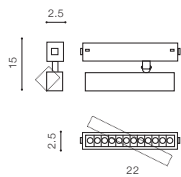

BETA OPTICA 230V TRACK MAGNETIC57



BK

**BETA OPTICA 230V TRACK MAGNETIC 7W**

3000K/4000K

LED integrated

voltage: 230V

LED 7W 336lm 3000K dimmable



IP20



LED 7W 395lm 4000K dimmable

technical

installation: BETA Track Magnetic 230V



specification

beam angle: 15°-38°



COLOUR / NEW INDEX NO.

- 3000K BLACK (BK) . . . . . **AZ5195**
- 4000K BLACK (BK) . . . . . **AZ5196**

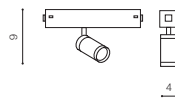

BK

**BETA OPTICA 230V TRACK MAGNETIC 10W**

3000K/4000K

LED integrated

voltage: 230V

LED 10W 805lm 3000K dimmable



IP20



LED 10W 847lm 4000K dimmable

technical

installation: BETA Track Magnetic 230V



specification

beam angle: 15°-38°



COLOUR / NEW INDEX NO.

- 3000K BLACK (BK) . . . . . **AZ5198**
- 4000K BLACK (BK) . . . . . **AZ5197**

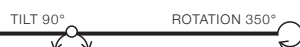
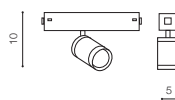

# BETA KERRY 230V TRACK MAGNETIC57

38 Track Magnetic System - BETA



BK

## BETA KERRY 230V TRACK MAGNETIC 10W 3000K

LED integrated

voltage: 230V

LED 10W 635lm 3000K

IP20



technical specification

installation: BETA Track Magnetic 230V

beam angle: 24°

COLOUR / NEW INDEX NO.

■ 3000K BLACK (BK) . . . . . **AZ5203**

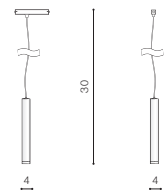

BK

## BETA KERRY 230V TRACK MAGNETIC 10W 4000K

LED integrated

voltage: 230V

LED 10W 654lm 4000K

IP20



technical specification

installation: BETA Track Magnetic 230V

beam angle: 24°

COLOUR / NEW INDEX NO.

■ 4000K BLACK (BK) . . . . . **AZ5204**

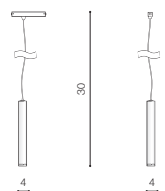



# BETA MAKITA 230V TRACK MAGNETIC57

Track Magnetic System - BETA 39



BK

**BETA MAKITA 230V TRACK MAGNETIC 10W**  
3000K/4000K LED integrated

voltage: 230V	LED 10W 728lm 3000K dimmable	<b>LED</b>
IP20	LED 10W 816lm 4000K dimmable	
technical specification	installation: BETA Track Magnetic 230V	<input type="checkbox"/>
	beam angle: 24°	<input type="checkbox"/>



BK

**BETA MAKITA 230V TRACK MAGNETIC 20W**  
3000K/4000K LED integrated

voltage: 230V	LED 20W 1396lm 3000K dimmable	<b>LED</b>
IP20	LED 20W 1557lm 4000K dimmable	
technical specification	installation: BETA Track Magnetic 230V	<input type="checkbox"/>
	beam angle: 24°	<input type="checkbox"/>

COLOUR / NEW INDEX NO.

- 3000K BLACK (BK) . . . . . **AZ5199**
- 4000K BLACK (BK) . . . . . **AZ5200**

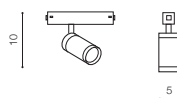

COLOUR / NEW INDEX NO.

- 3000K BLACK (BK) . . . . . **AZ5201**
- 4000K BLACK (BK) . . . . . **AZ5202**

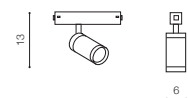

# BETA GARY 230V TRACK MAGNETIC57 GU10

40 Track Magnetic System - BETA



## BETA GARY 230V TRACK MAGNETIC GU10

bulb not included

voltage: 230V	GU10 1x MAX 50W	
IP20		
	installation: BETA Track Magnetic 230V	

COLOUR / NEW INDEX NO.

- BLACK (BK) . . . . . **AZ5207**
- WHITE (WH) . . . . . **AZ5208**

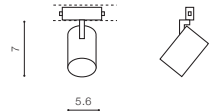

BETA BACKER 230V TRACK MAGNETIC57 GU10



**BETA BECKER 230V TRACK MAGNETIC GU10**

bulb not included

voltage: 230V	GU10 1x MAX 40W	
IP20		
	installation: BETA Track Magnetic 230V	

COLOUR / NEW INDEX NO.

- BLACK (BK) . . . . . **AZ5465**
- WHITE (WH). . . . . **AZ5466**

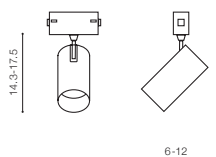

# REMOTE CONTROL BLUETOOTH

## Remote Control 4-Group & RGB & Bluetooth Operating Schematic

AZ5265

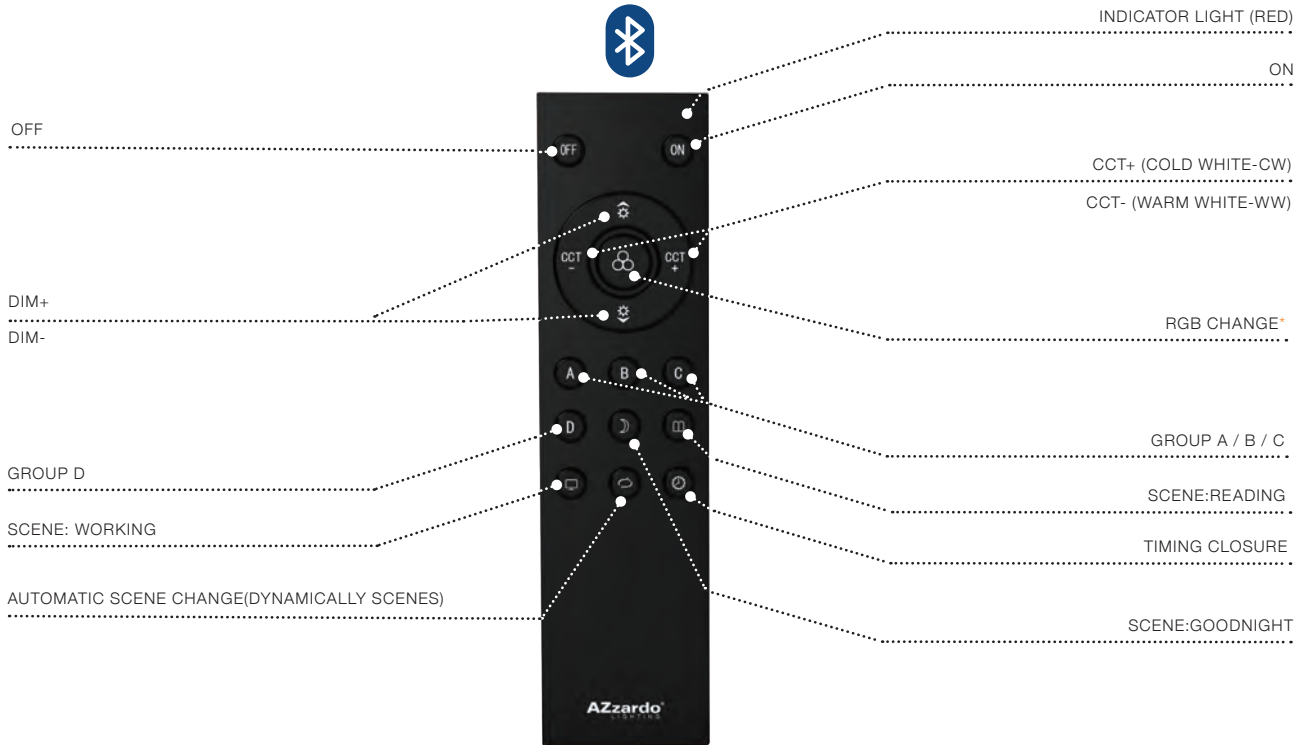

\*RGB CHANGE ONLY USED FOR RGB LAMPS  
THE CCT LAMP CAN'T BE USE THIS BUTTON FUNCTION

## Remote Control 3 Group Operating Schematic

AZ4857

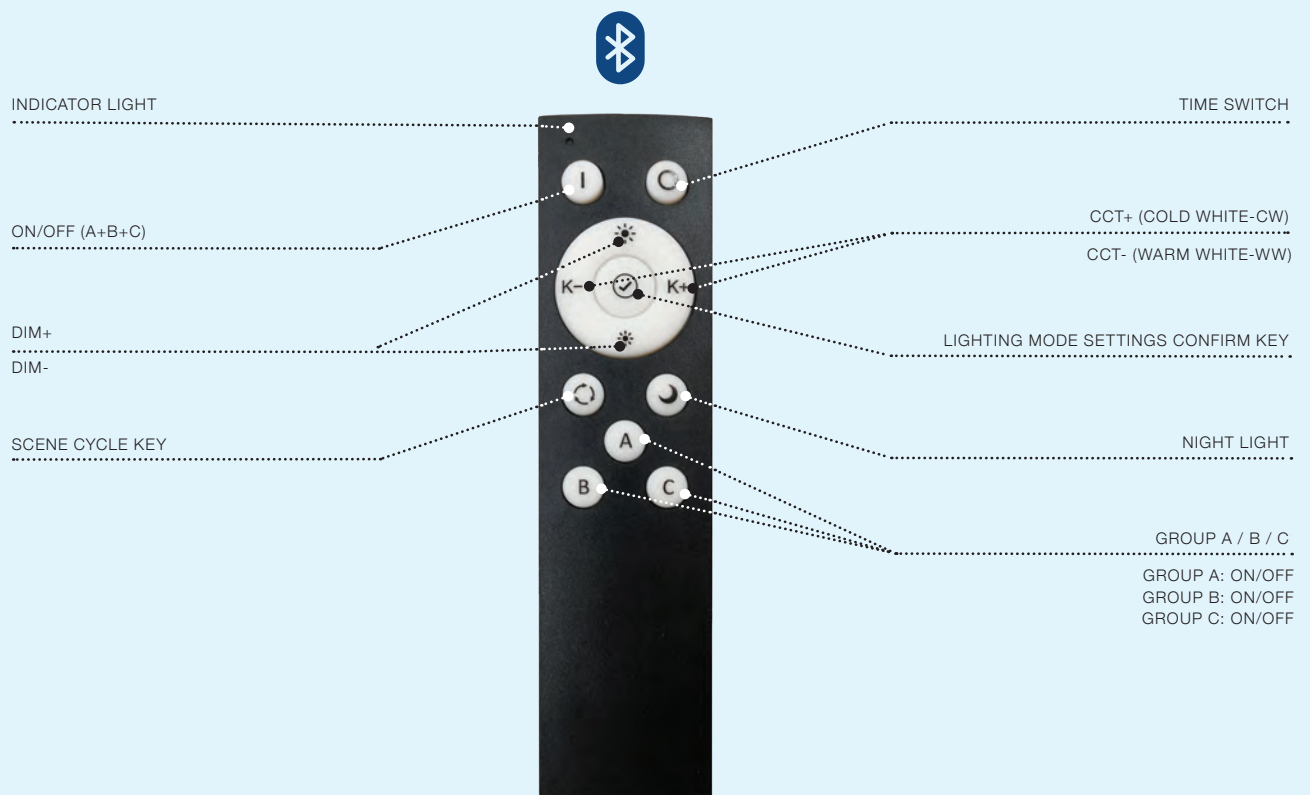

Switch Panel Remote Control 2-Group Bluetooth Bk

Operating Schematic

AZ5209

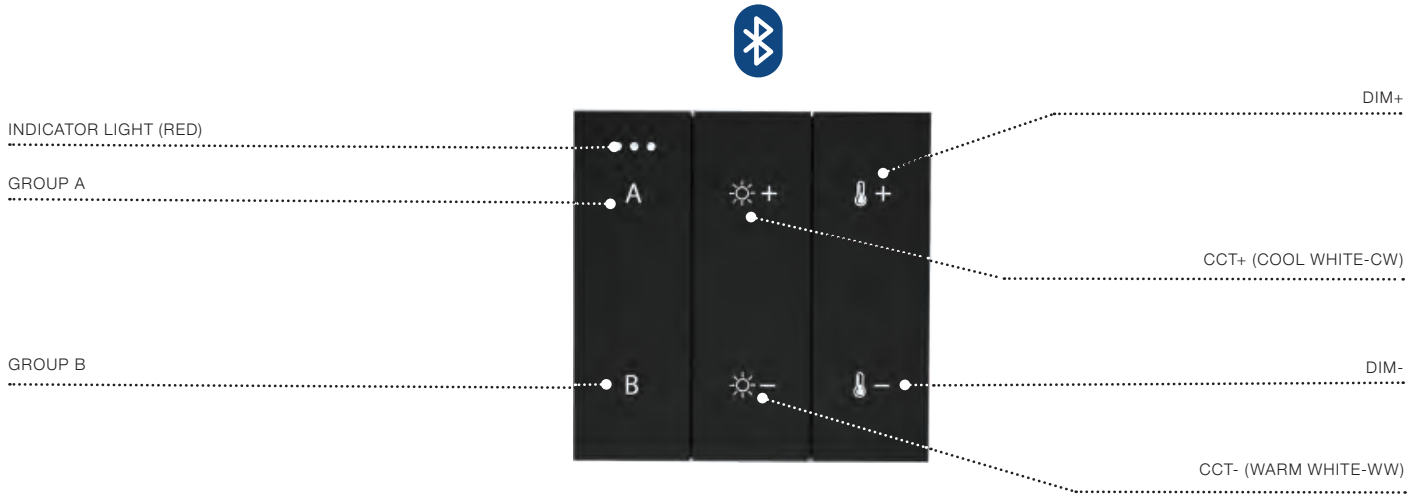

Switch Panel Remote Control 2-Group Bluetooth

SWITCH PANEL REMOTE CONTROL 2-GROUP BLUETOOTH (WH) . . . . . AZ5210

DOWNLOAD THE APP



STANDARD

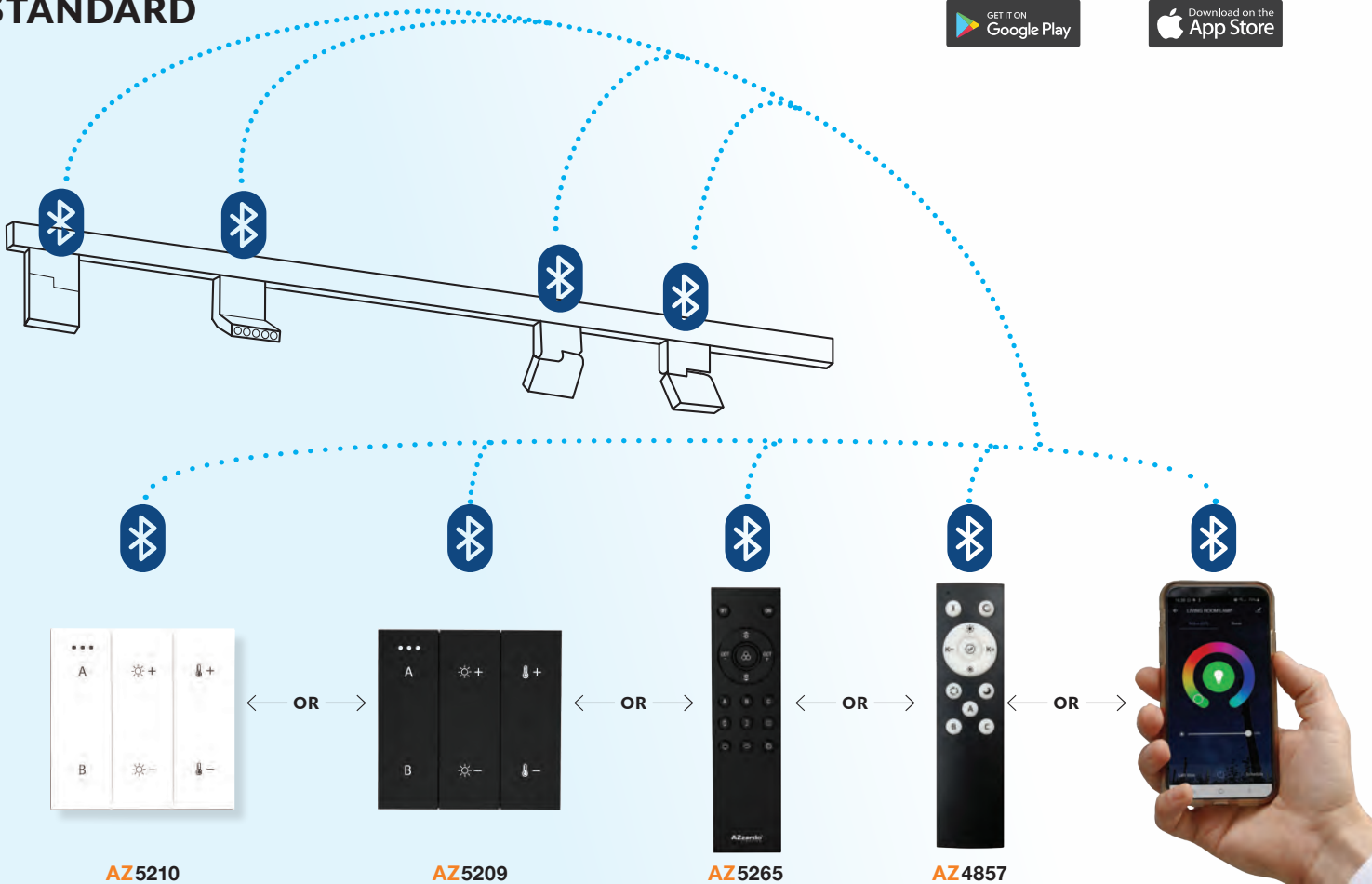

AZ5210

AZ5209

AZ5265

AZ4857

# BETA KIRA 230V TRACK MAGNETIC57 CCT BLUETOOTH

44 Track Magnetic System - BETA



## BETA KIRA 230V TRACK MAGNETIC 9W CCT BLUETOOTH LED integrated

voltage: 230V	LED 9W 1033lm CCT 3000-6000K		<b>LED</b>
IP20	dimnable		
technical specification	installation: BETA Track Magnetic 230V	<input type="checkbox"/>	<input type="checkbox"/>
	beam angle: 24°	<input type="checkbox"/>	<input type="checkbox"/>

COLOUR / NEW INDEX NO.

BLACK (BK) . . . . . **AZ5175**
2.5

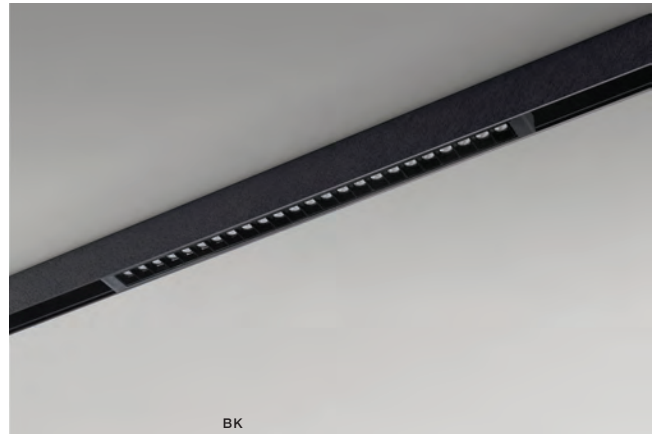

## BETA KIRA 230V TRACK MAGNETIC 18W CCT BLUETOOTH LED integrated

voltage: 230V	LED 18W 1962lm CCT 3000-6000K		<b>LED</b>
IP20	dimnable		
technical specification	installation: BETA Track Magnetic 230V	<input type="checkbox"/>	<input type="checkbox"/>
	beam angle: 24°	<input type="checkbox"/>	<input type="checkbox"/>

COLOUR / NEW INDEX NO.

BLACK (BK) . . . . . **AZ5176**
2.5

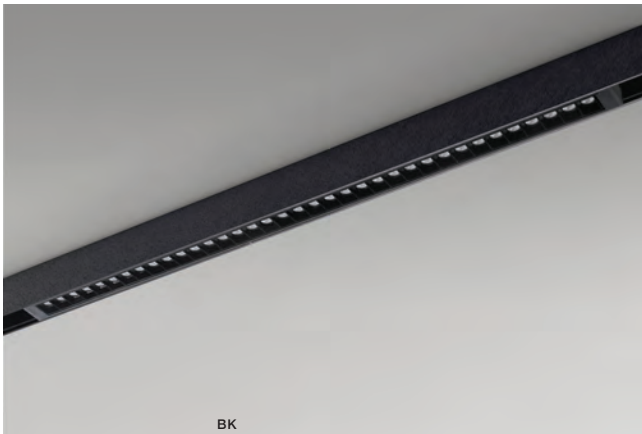

## BETA KIRA 230V TRACK MAGNETIC 27W CCT BLUETOOTH LED integrated

voltage: 230V	LED 27W 3420lm CCT 3000-6000K		<b>LED</b>
IP20	dimnable		
technical specification	installation: BETA Track Magnetic 230V	<input type="checkbox"/>	<input type="checkbox"/>
	beam angle: 24°	<input type="checkbox"/>	<input type="checkbox"/>

COLOUR / NEW INDEX NO.

BLACK (BK) . . . . . **AZ5177**
2.5



BETA SAGA 230V TRACK MAGNETIC57 RGB-CW BLUETOOTH

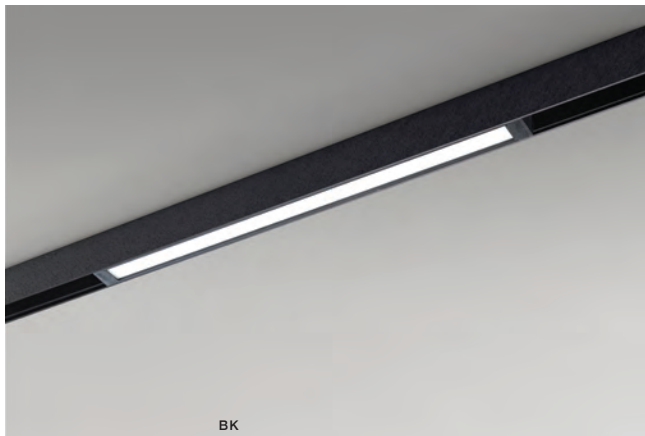

BK

**BETA SAGA 230V TRACK MAGNETIC 18W**

RGB-CW BLUETOOTH

LED integrated

voltage: 230V

LED 18W 1503lm 3000K-6000K



IP20

dimmable

technical

installation: BETA Track Magnetic 230V



specification



beam angle: 120°



COLOUR / NEW INDEX NO.

■ BLACK (BK) . . . . . **AZ5205**



# BETA SAGA 230V TRACK MAGNETIC 57 CCT BLUETOOTH

46 Track Magnetic System - BETA



BK

## BETA SAGA 230V TRACK MAGNETIC 9W CCT BLUETOOTH

LED integrated

voltage: 230V	LED 19W 1503lm CCT 3000K-6000K	<b>LED</b>
IP20	dimnable	
technical specification	installation: BETA Track Magnetic 230V	<input type="checkbox"/>
	beam angle: 120°	<input type="checkbox"/>



COLOUR / NEW INDEX NO.

<input checked="" type="checkbox"/> BLACK (BK) . . . . .	<b>AZ5178</b>	4
		2,5



BK

## BETA SAGA 230V TRACK MAGNETIC 18W CCT BLUETOOTH

LED integrated

voltage: 230V	LED 18W 1503lm CCT 3000-6000K	<b>LED</b>
IP20	dimnable	
technical specification	installation: BETA Track Magnetic 230V	<input type="checkbox"/>
	beam angle: 120°	<input type="checkbox"/>



COLOUR / NEW INDEX NO.

<input checked="" type="checkbox"/> BLACK (BK) . . . . .	<b>AZ5179</b>	4
		2,5

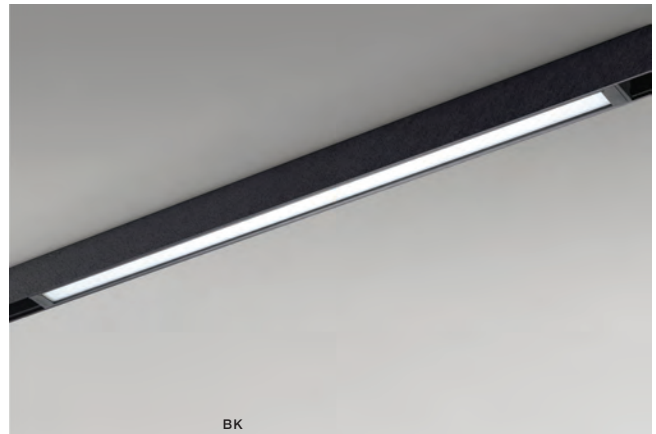

BK

## BETA SAGA 230V TRACK MAGNETIC 27W CCT BLUETOOTH

LED integrated

voltage: 230V	LED 27W 2695lm CCT 3000-6000K	<b>LED</b>
IP20	dimnable	
technical specification	installation: BETA Track Magnetic 230V	<input type="checkbox"/>
	beam angle: 120°	<input type="checkbox"/>



COLOUR / NEW INDEX NO.

<input checked="" type="checkbox"/> BLACK (BK) . . . . .	<b>AZ5180</b>	4
		2,5



## BETA SAGA 230V TRACK MAGNETIC57 CCT BLUETOOTH

Track Magnetic System - BETA 47



# BETA SANDERS 230V TRACK MAGNETIC57 CCT BLUETOOTH

48 Track Magnetic System - BETA



**BETA SANDERS 230V TRACK MAGNETIC 9W**  
CCT BLUETOOTH LED integrated

voltage: 230V	LED 9W 1010lm CCT 3000-6000K	<b>LED</b>
IP20	dimmable	
technical specification	installation: BETA Track Magnetic 230V	<input type="checkbox"/>
	beam angle: 24°	<input type="checkbox"/>

COLOUR / NEW INDEX NO.

■ BLACK (BK) . . . . . **AZ5181**

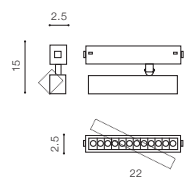

# BETA OPTICA 230V TRACK MAGNETIC57 CCT BLUETOOTH

Track Magnetic System - BETA



BK

## BETA OPTICA 230V TRACK MAGNETIC 7W CCT BLUETOOTH

LED integrated

voltage: 230V	LED 7W 467lm CCT 3000-6000K	
IP20	dimmable	
technical specification		installation: BETA Track Magnetic 230V
		beam angle: 15°±38°

COLOUR / NEW INDEX NO.

■ BLACK (BK) . . . . . **AZ5182**

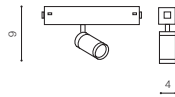

BK

## BETA OPTICA 230V TRACK MAGNETIC 10W CCT BLUETOOTH

LED integrated

voltage: 230V	LED 10W 1143lm CCT 3000-6000K	
IP20	dimmable	
technical specification		installation: BETA Track Magnetic 230V
		beam angle: 15°±38°

COLOUR / NEW INDEX NO.

■ BLACK (BK) . . . . . **AZ5183**

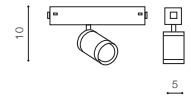

# BETA KERRY 230V TRACK MAGNETIC57 CCT BLUETOOTH

50 Track Magnetic System - BETA



BK

## BETA KERRY 230V TRACK MAGNETIC 10W CCT BLUETOOTH

LED integrated

voltage: 230V	LED 10W 1046lm CCT 3000-6000K	<b>LED</b>
IP20	dimmable	
technical specification	installation: BETA Track Magnetic 230V	<input checked="" type="checkbox"/>
	beam angle: 24°	<input checked="" type="checkbox"/>

COLOUR / NEW INDEX NO.

■ BLACK (BK) . . . . . **AZ5186**

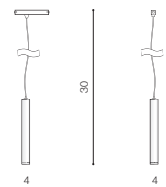

# BETA MAKITA 230V TRACK MAGN.57 RGB-CW CCT BLUETOOTH



BK

## BETA MAKITA 230V TRACK MAGNETIC 10W RGB-CW CCT BLUETOOTH

LED integrated

voltage: 230V

LED 10W 1234lm RGB-CW CCT



IP20



3000K-6000K dimmable

technical

installation: BETA Track Magnetic 230V



specification

beam angle: 24°



COLOUR / NEW INDEX NO.

■ BLACK (BK) . . . . . **AZ5206**

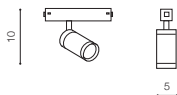

# BETA MAKITA 230V TRACK MAGNETIC57 CCT BLUETOOTH

52 Track Magnetic System - BETA



BK

## BETA MAKITA 230V TRACK MAGNETIC 10W CCT BLUETOOTH

LED integrated

voltage: 230V	LED 10W 1234lm CCT 3000-6000K	<b>LED</b>
IP20	dimmable	
technical specification	installation: BETA Track Magnetic 230V	<input type="checkbox"/>
	beam angle: 24°	<input checked="" type="checkbox"/>



COLOUR / NEW INDEX NO.

■ BLACK (BK) . . . . . **AZ5184**

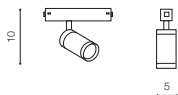

BK

## BETA MAKITA 230V TRACK MAGNETIC 20W CCT BLUETOOTH

LED integrated

voltage: 230V	LED 20W 2388lm CCT 3000-6000K	<b>LED</b>
IP20	dimmable	
technical specification	installation: BETA Track Magnetic 230V	<input type="checkbox"/>
	beam angle: 24°	<input checked="" type="checkbox"/>



COLOUR / NEW INDEX NO.

■ BLACK (BK) . . . . . **AZ5185**

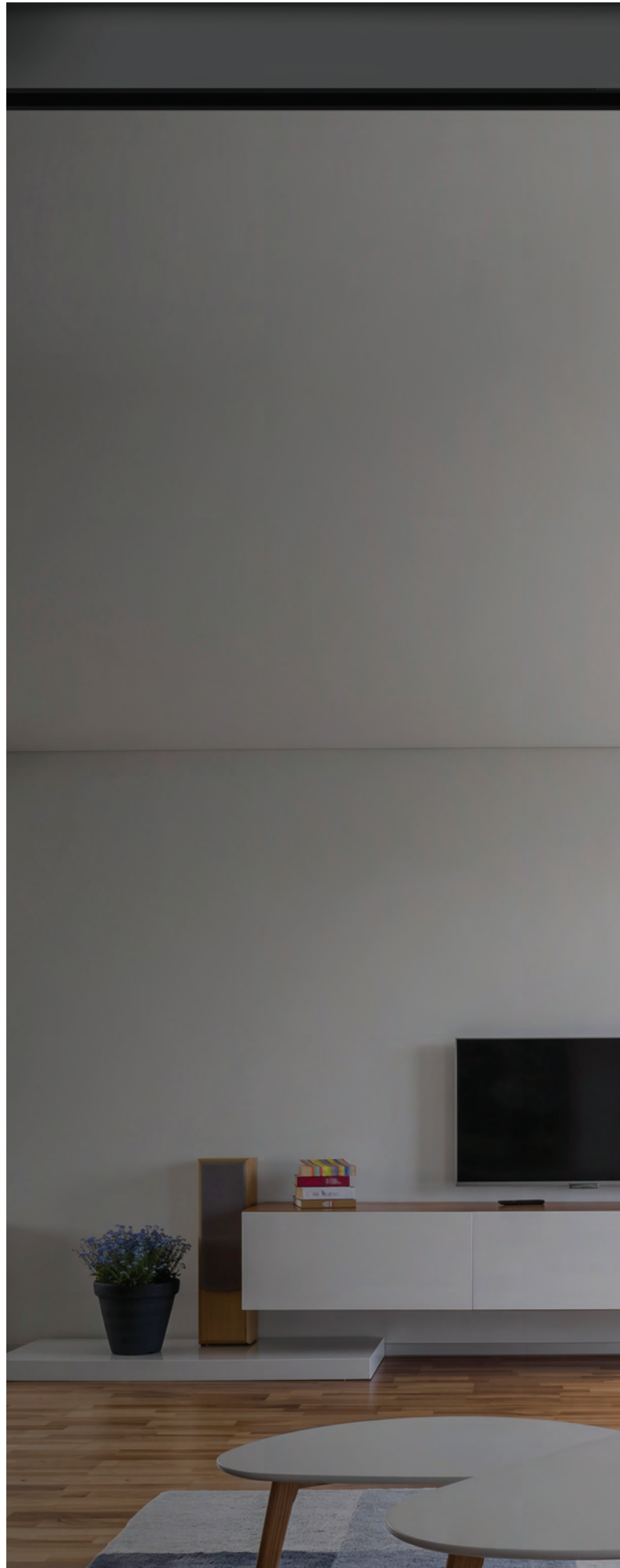
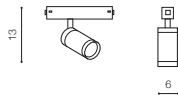

## BETA MAKITA 230V TRACK MAGNETIC57 CCT BLUETOOTH

Track Magnetic System - BETA 53



SYSTEM COMPONENTS NAMES FOR TRACK MAGNETIC SYSTEM - NEO

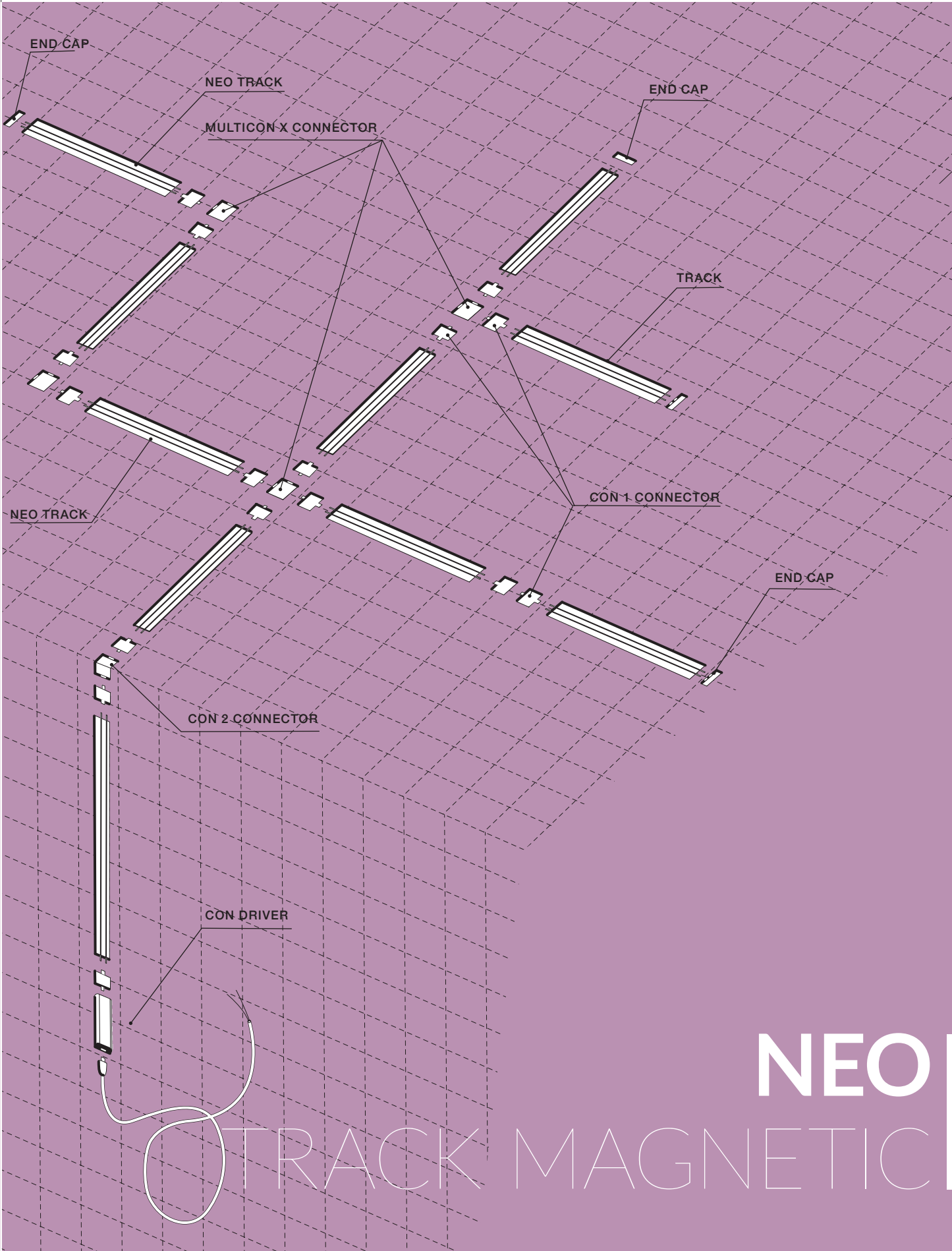



# NEO

track Magnetic

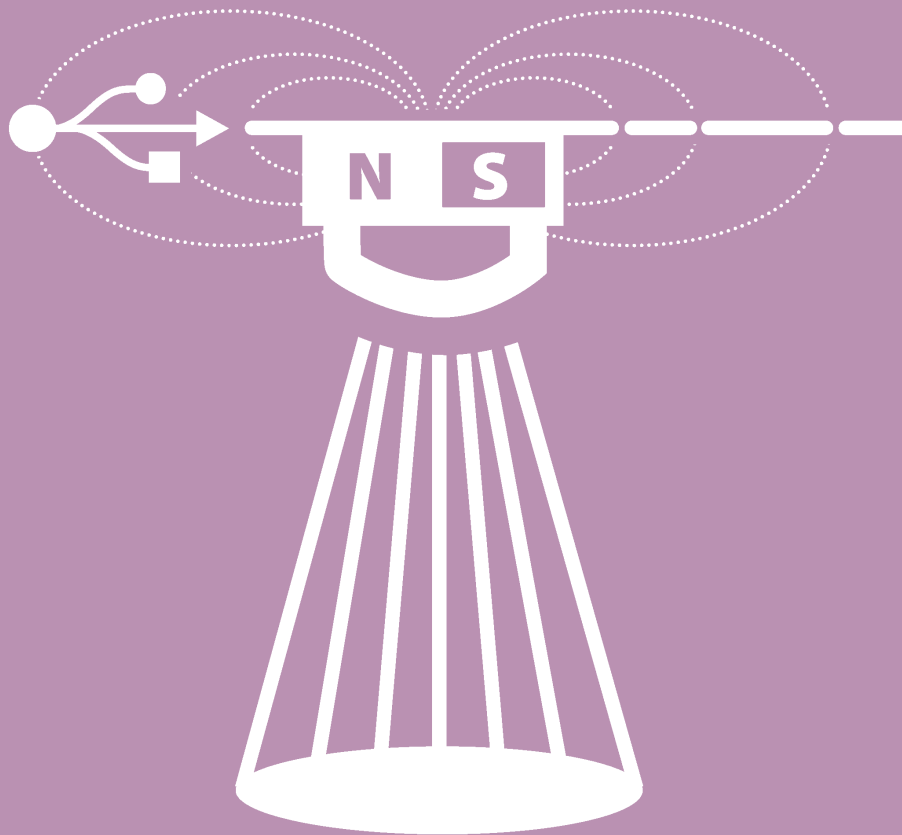

# NEO TRACK MAGNETIC

56

Components for NEO Track Magnetic

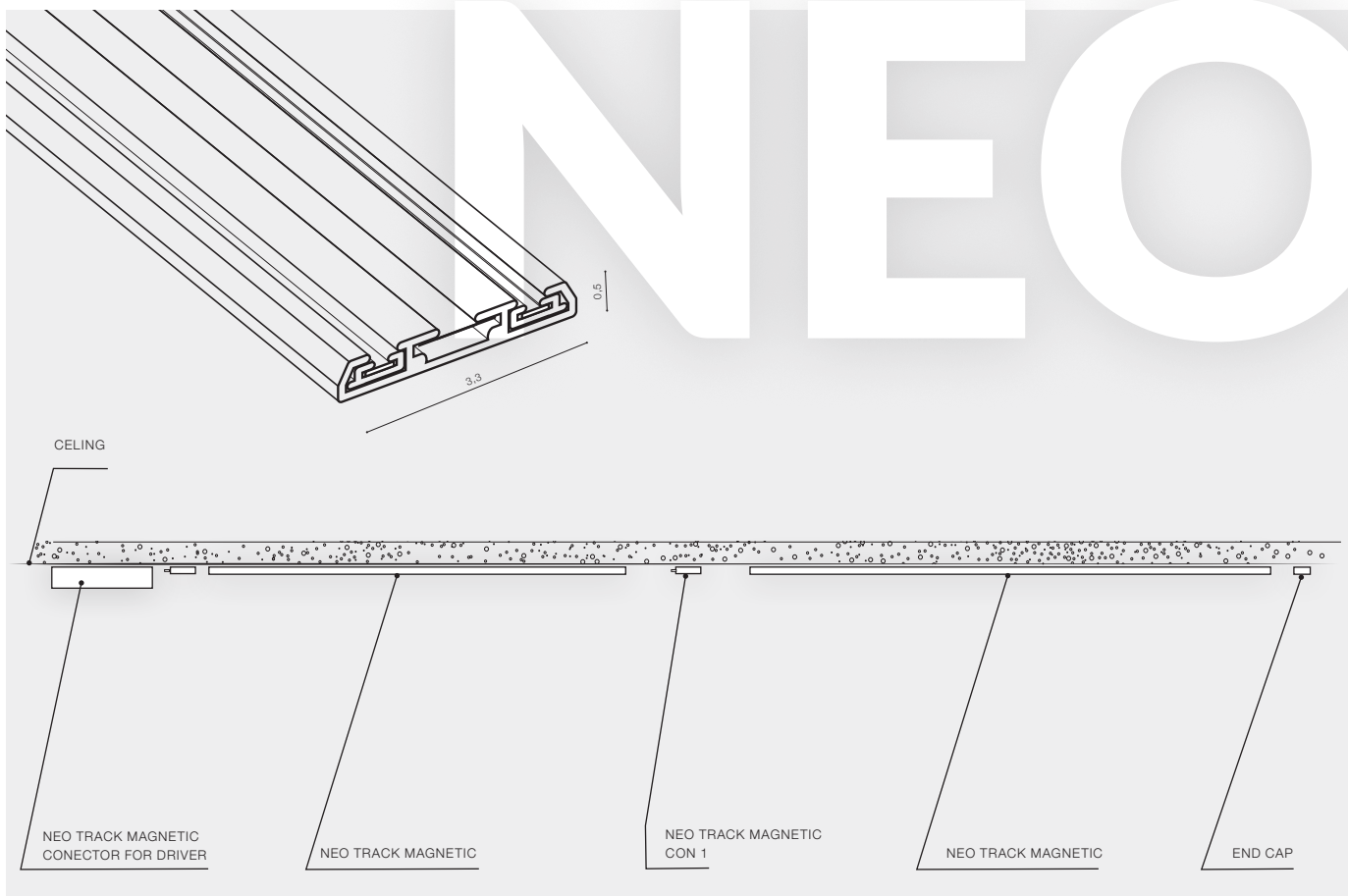

## NEO TRACK MAGNETIC (30, 60, 120, 200)

- TRACK MAGNETIC NEO 0,3M (BLACK) . . . . . **AZ5129**
- TRACK MAGNETIC NEO 0,6M (BLACK) . . . . . **AZ5130**
- TRACK MAGNETIC NEO 1,2M (BLACK) . . . . . **AZ5131**
- TRACK MAGNETIC NEO 2,0M (BLACK) . . . . . **AZ5132**



## NEO TRACK MAGNETIC DRIVER 100W / 200W

- TRACK MAGNETIC NEO DRIVER 100W (BLACK) . . . . . **AZ5137**
- TRACK MAGNETIC NEO DRIVER 200W (BLACK) . . . . . **AZ5138**

Available options for installation place (surface and pendant mounted)

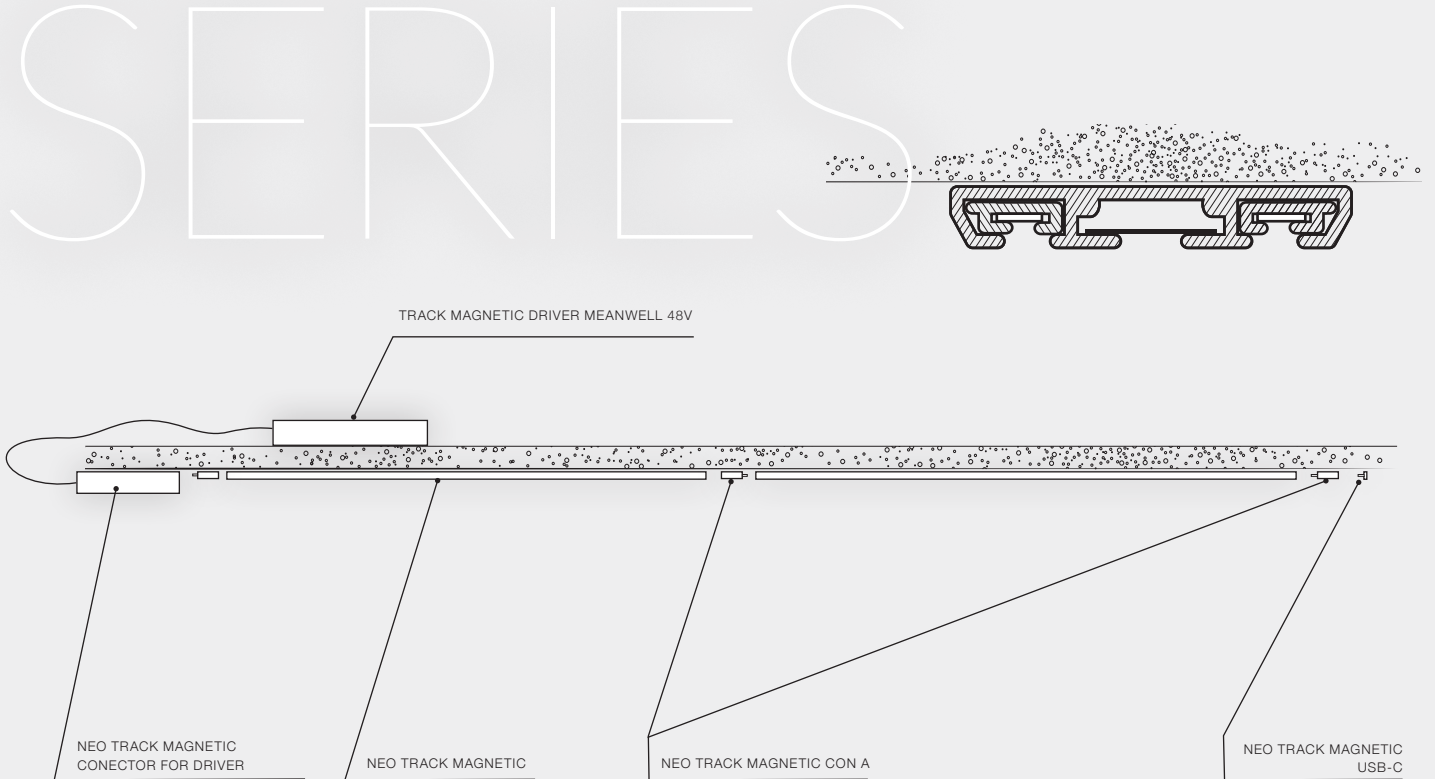

**TRACK MAGNETIC DRIVER MEANWELL 48V  
100W / 200W / 350W**

THIS DRIVER IS UNIVERSAL FOR SYSTEMS:  
ALFA, GAMMA, NEO

- DRIVER MEANWELL (100W) . . . . . **AZ4691**
- DRIVER MEANWELL (200W) . . . . . **AZ4692**
- DRIVER MEANWELL (350W) . . . . . **AZ4866**

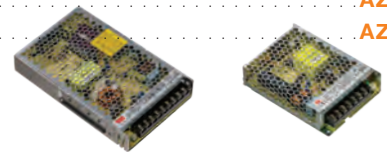

**NEO TRACK MAGNETIC CONNECTOR FOR  
DRIVER**

- TRACK MAGNETIC NEO CONNECTOR FOR DRIVER (BLACK) . . . . . **AZ5134**

# NEO TRACK MAGNETIC

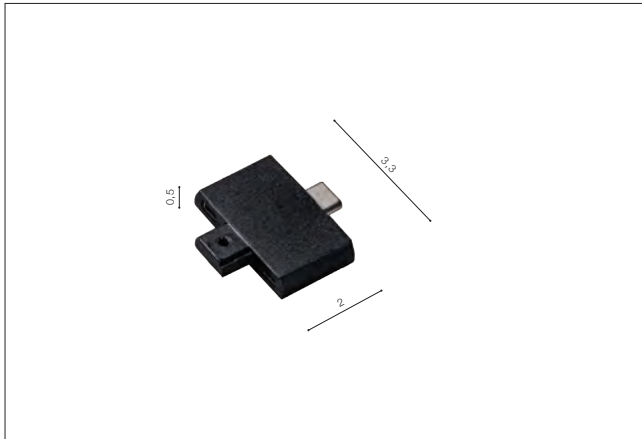

## NEO TRACK MAGNETIC CON 1

■ TRACK MAGNETIC NEO CON 1 (BLACK) . . . . . **AZ5136**



## NEO TRACK MAGNETIC CON 2

■ NEO TRACK MAGNETIC CON 2 (BLACK) . . . . . **AZ5133**

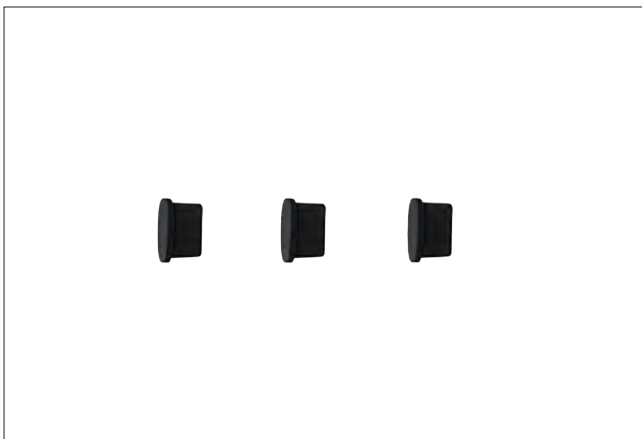

## NEO TRACK MAGNETIC COVER USB-C 3X

■ TRACK MAGNETIC COVER USB-C 3X (BLACK) . . . . . **AZ5464**



## NEO TRACK MAGNETIC MICRO COVER 3X

■ TRACK MAGNETIC NEO MICRO COVER 3X (BLACK). . . . . **AZ5456**



## NEO TRACK MAGNETIC MULTICON X

■ TRACK MAGNETIC NEO MULTICON X (BLACK) . . . . .AZ5135



# REMOTE CONTROL BLUETOOTH

## Remote Control 4-Group & RGB & Bluetooth Operating Schematic

AZ5265

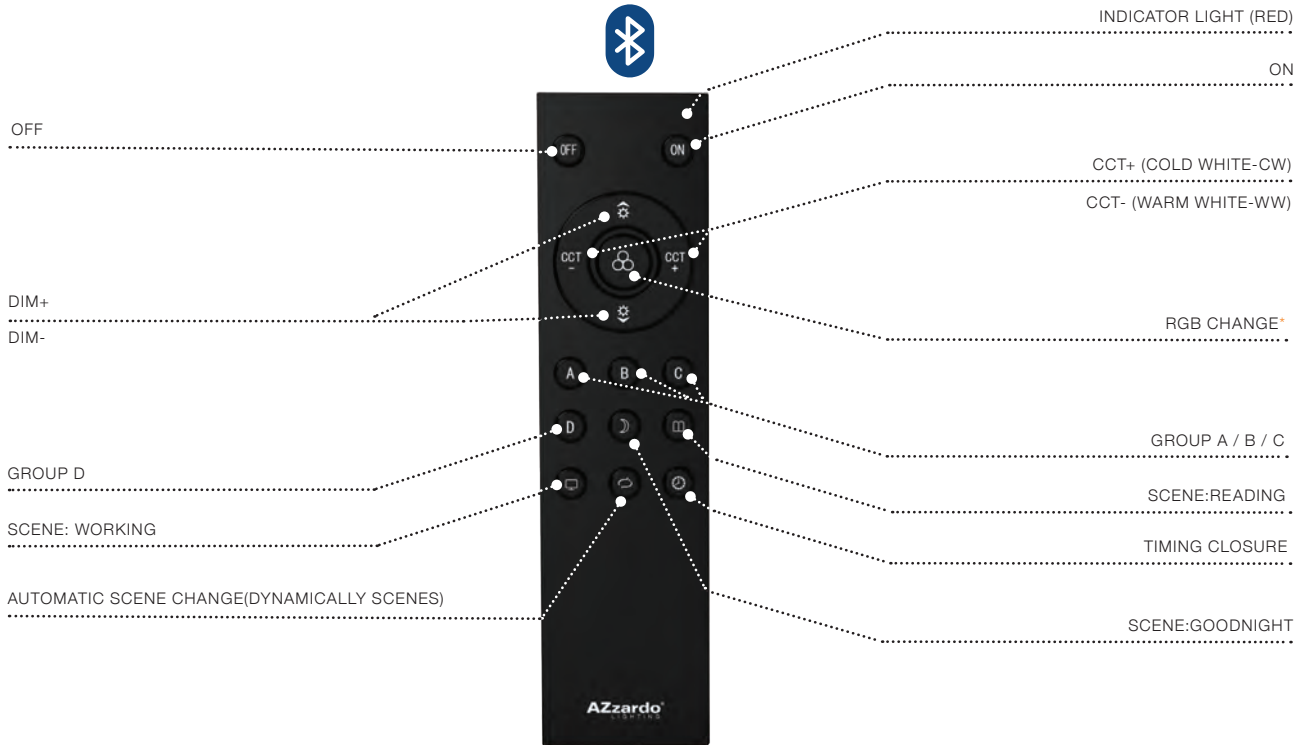

\*RGB CHANGE ONLY USED FOR RGB LAMPS  
THE CCT LAMP CAN'T BE USE THIS BUTTON FUNCTION

## Remote Control 3 Group Operating Schematic

AZ4857

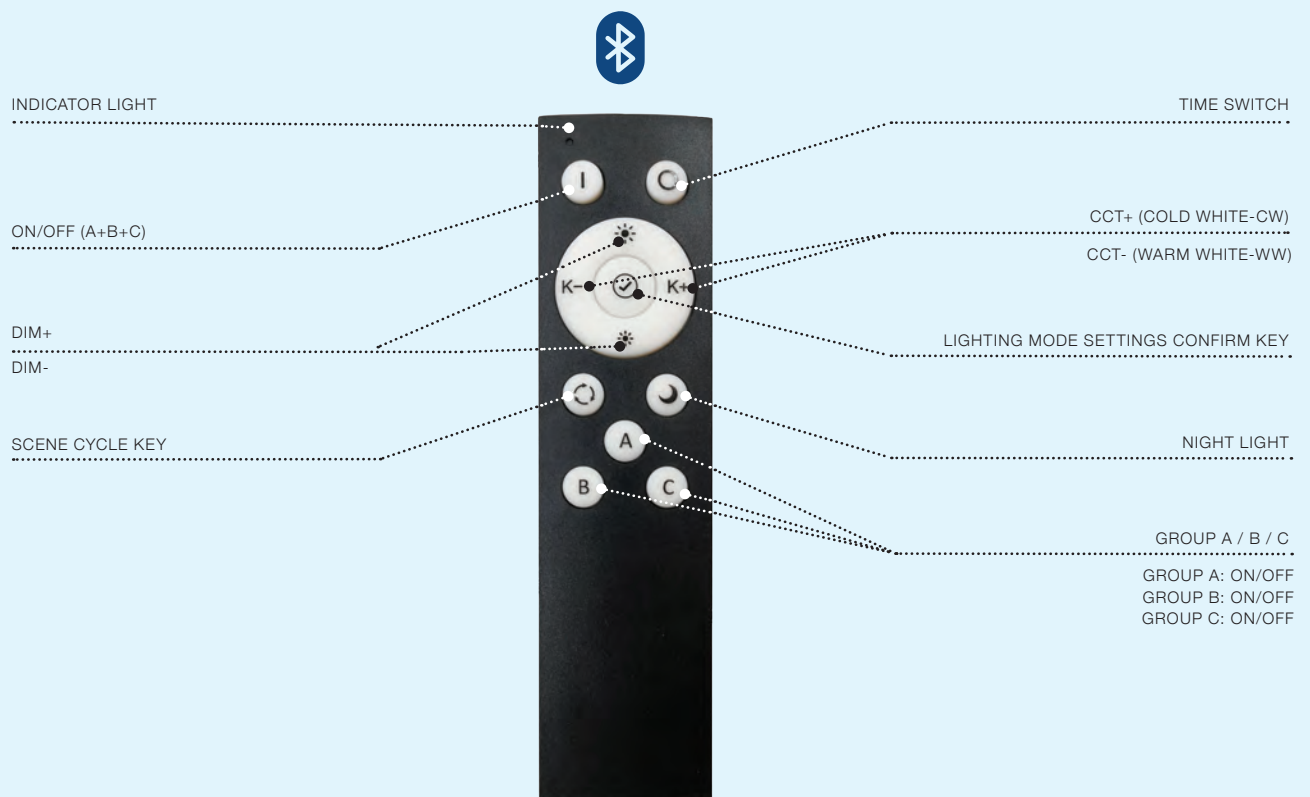

Switch Panel Remote Control 2-Group Bluetooth Bk

Operating Schematic

AZ5209

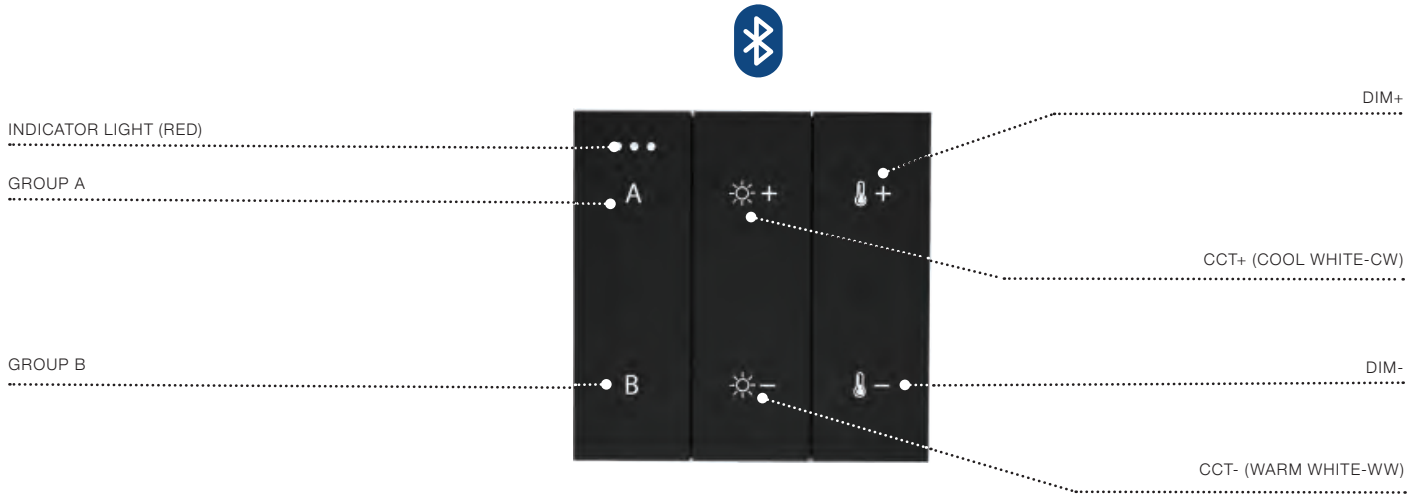

Switch Panel Remote Control 2-Group Bluetooth

SWITCH PANEL REMOTE CONTROL 2-GROUP BLUETOOTH (WH) . . . . . AZ5210

DOWNLOAD THE APP



STANDARD

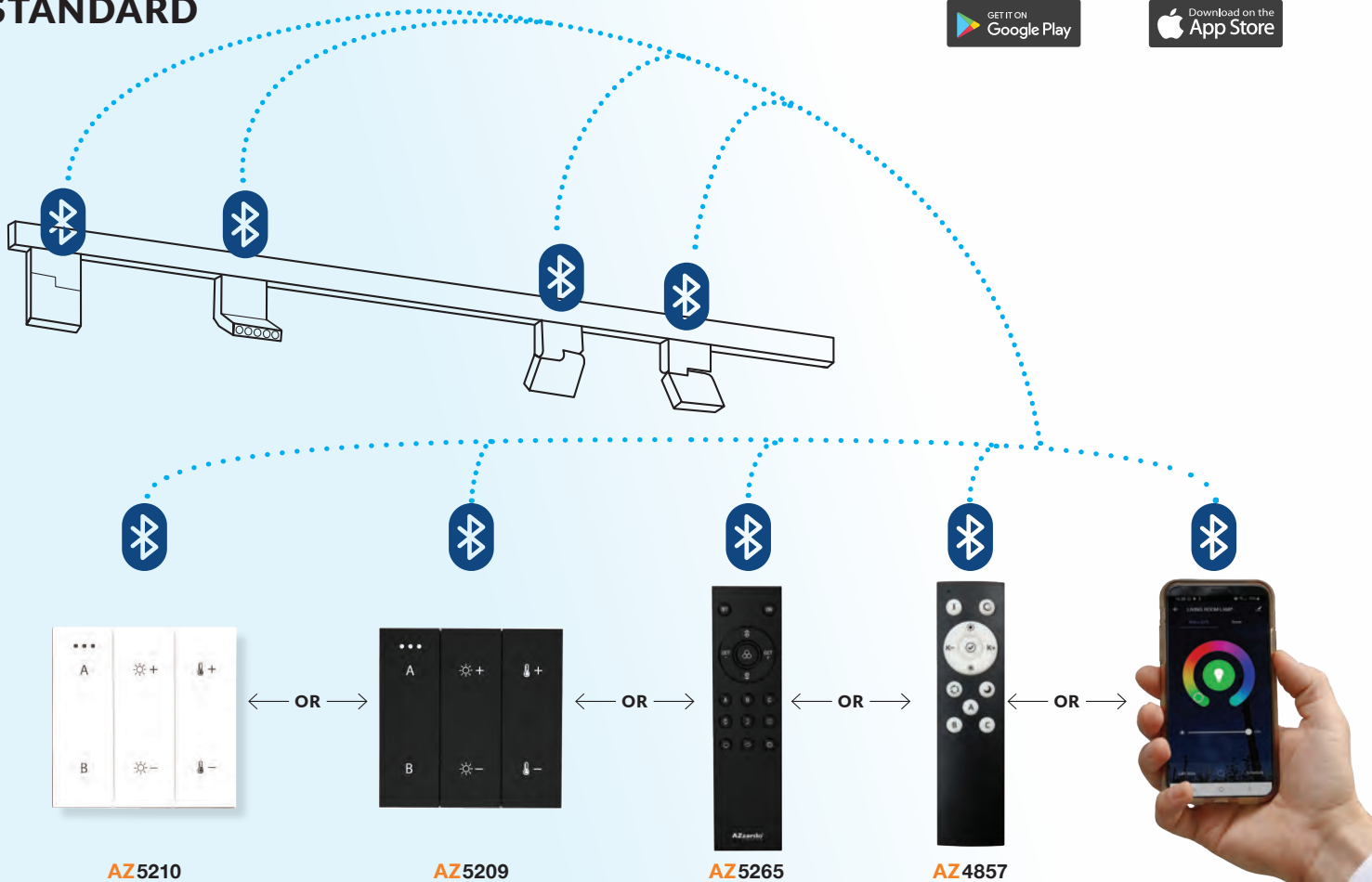

# NEO SERIE 100 TRACK MAGNETIC CCT BLUETOOTH

62 Track Magnetic System - NEO

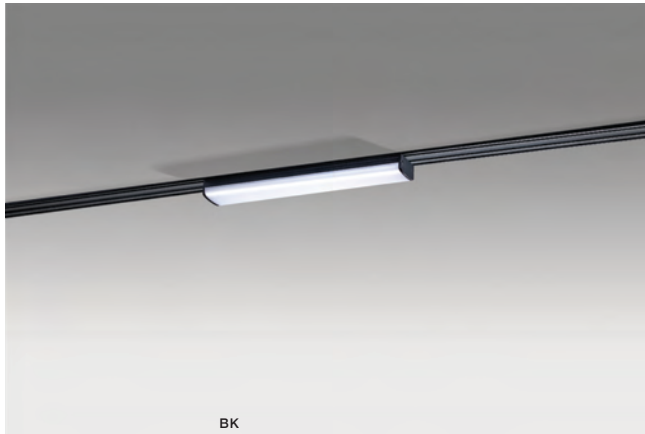

BK

## NEO SERIE 100 6W CCT BLUETOOTH

LED integrated

voltage: 48V	LED 6W 384lm CCT 3000K – 6400K		<b>LED</b>
IP20	>90 CRI dimmable		
technical specification	installation: NEO Track Magnetic		
	beam angle: 120°		

COLOUR / NEW INDEX NO.

■ BLACK (BK) . . . . . **AZ5118**

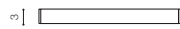
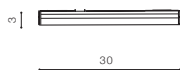

BK

## NEO SERIE 100 12W CCT BLUETOOTH

LED integrated

voltage: 48V	LED 12W 768lm CCT 3000K – 6400K		<b>LED</b>
IP20	>90 CRI dimmable		
technical specification	installation: NEO Track Magnetic		
	beam angle: 120°		

COLOUR / NEW INDEX NO.

■ BLACK (BK) . . . . . **AZ5119**

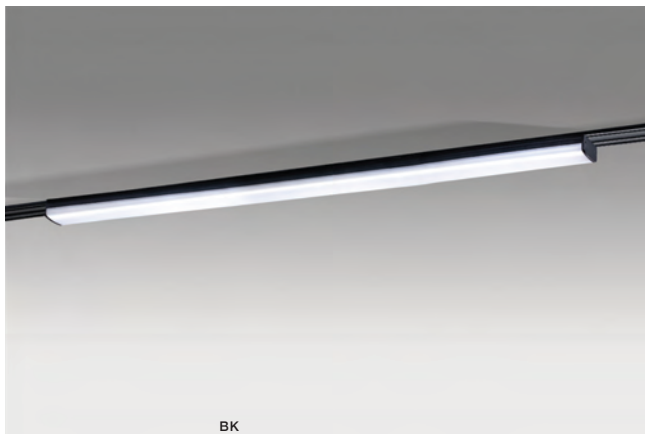
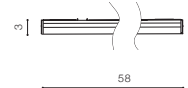

BK

## NEO SERIE 100 21W CCT BLUETOOTH

LED integrated

voltage: 48V	LED 21W 1344lm CCT 3000K – 6400K		<b>LED</b>
IP20	>90 CRI dimmable		
technical specification	installation: NEO Track Magnetic		
	beam angle: 120°		

COLOUR / NEW INDEX NO.

■ BLACK (BK) . . . . . **AZ5120**

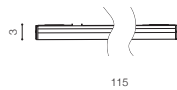



# NEO SERIE 100 TRACK MAGNETIC CCT BLUETOOTH

Track Magnetic System - NEO 63

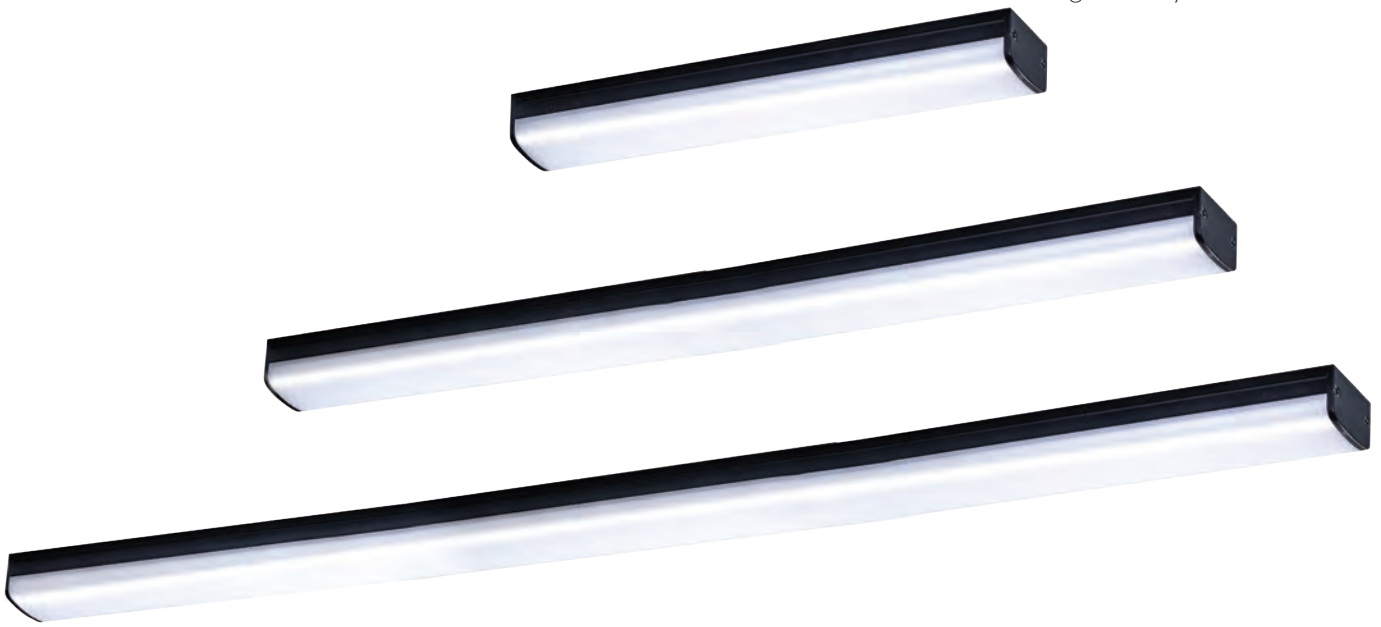

# NEO SERIE 120 TRACK MAGNETIC CCT BLUETOOTH

64 Track Magnetic System - NEO



# NEO SERIE 120 TRACK MAGNETIC CCT BLUETOOTH

Track Magnetic System – NEO 65



## NEO SERIE 120 8W CCT BLUETOOTH

LED integrated

voltage: 48V

LED 8W 326lm CCT 3000K – 6970K

IP20

>90 CRI dimmable

**LED**

technical

installation: NEO Track Magnetic

specification

beam angle: 33°



COLOUR / NEW INDEX NO.

BLACK (BK) . . . . . **AZ5121**

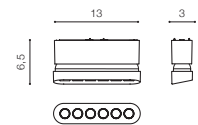

# NEO SERIE 140 TRACK MAGNETIC CCT BLUETOOTH

66 Track Magnetic System - NEO



## NEO SERIE 140 9W CCT BLUETOOTH

LED integrated

voltage: 48V	LED 9W 367lm CCT 3000K – 6700K		<b>LED</b>
IP20	>90 CRI dimmable		
technical specification	installation: NEO Track Magnetic		
	beam angle: 36°		

COLOUR / NEW INDEX NO.

■ BLACK (BK) . . . . . **AZ5126**

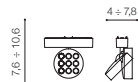

## NEO SERIE 140 12W CCT BLUETOOTH

LED integrated

voltage: 48V	LED 12W 717lm CCT 3000K – 6700K		<b>LED</b>
IP20	>90 CRI dimmable		
technical specification	installation: NEO Track Magnetic		
	beam angle: 35°		

COLOUR / NEW INDEX NO.

■ BLACK (BK) . . . . . **AZ5122**

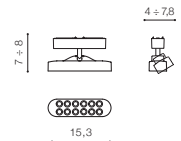

## NEO SERIE 140 18W CCT BLUETOOTH

LED integrated

voltage: 48V	LED 18W 1313lm CCT 3000K - 6700K		<b>LED</b>
IP20	>90 CRI dimmable		
technical specification	installation: NEO Track Magnetic		
	beam angle: 37°		

COLOUR / NEW INDEX NO.

■ BLACK (BK) . . . . . **AZ5123**

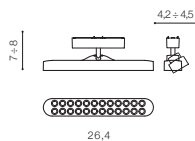

## NEO SERIE 140 TRACK MAGNETIC CCT BLUETOOTH

Track Magnetic System – NEO 67



# NEO SERIE 160 TRACK MAGNETIC CCT BLUETOOTH

68 Track Magnetic System - NEO

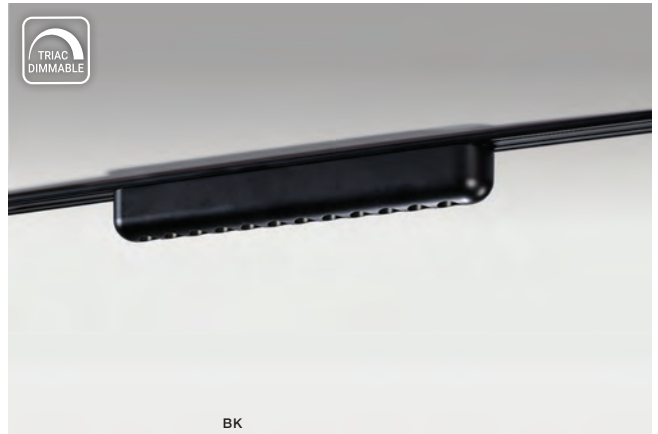

BK

## NEO SERIE 160 12W CCT BLUETOOTH

LED integrated

voltage: 48V	LED 12W 850lm CCT 3000K - 6880K		<b>LED</b>
IP20	>90 CRI dimmable		
technical specification	installation: NEO Track Magnetic	<input type="checkbox"/>	<input type="checkbox"/>
	beam angle: 36°		<input type="checkbox"/>

COLOUR / NEW INDEX NO.

■ BLACK (BK) . . . . . **AZ5124**

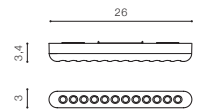

# NEO SERIE 180 TRACK MAGNETIC CCT BLUETOOTH

Track Magnetic System – NEO 69



## NEO SERIE 180 6W CCT BLUETOOTH

LED integrated

voltage: 48V	LED 6W 397lm CCT 3000K - 5600K	<b>LED</b>
IP20	>90 CRI dimmable	
technical specification	installation: NEO Track Magnetic	<input type="checkbox"/>
	beam angle: 147°	<input checked="" type="checkbox"/>

COLOUR / NEW INDEX NO.

■ BLACK (BK) . . . . . **AZ5125**

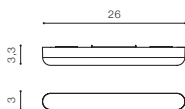

# NEO SERIE 200 TRACK MAGNETIC CCT BLUETOOTH

70 Track Magnetic System - NEO



**NEO SERIE 200 12W CCT BLUETOOTH**

LED integrated

voltage: 48V	LED 12W 850lm CCT 3000K - 6600K	<b>LED</b>
IP20	>90 CRI dimmable	
technical specification	installation: NEO Track Magnetic	<input type="checkbox"/>
	beam angle: 41°	<input checked="" type="checkbox"/>

COLOUR / NEW INDEX NO.

■ BLACK (BK) . . . . . **AZ5127**

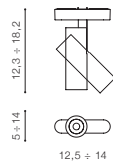



NEO SERIE 220 TRACK MAGNETIC CCT BLUETOOTH



NEO SERIE 220 9W CCT BLUETOOTH

LED integrated

voltage: 48V	LED 9W 310lm CCT 3000K - 6400K	<b>LED</b>
IP20	>90 CRI dimmable	
technical specification	installation: NEO Track Magnetic	<input type="checkbox"/>
	beam angle: 106°	<input checked="" type="checkbox"/>

COLOUR / NEW INDEX NO.

■ BLACK (BK) . . . . . **AZ5128**

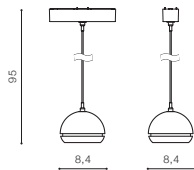

NAMING OF BASIC ACCESSORIES FOR TRACK MAGNETIC SYSTEM - ALFA

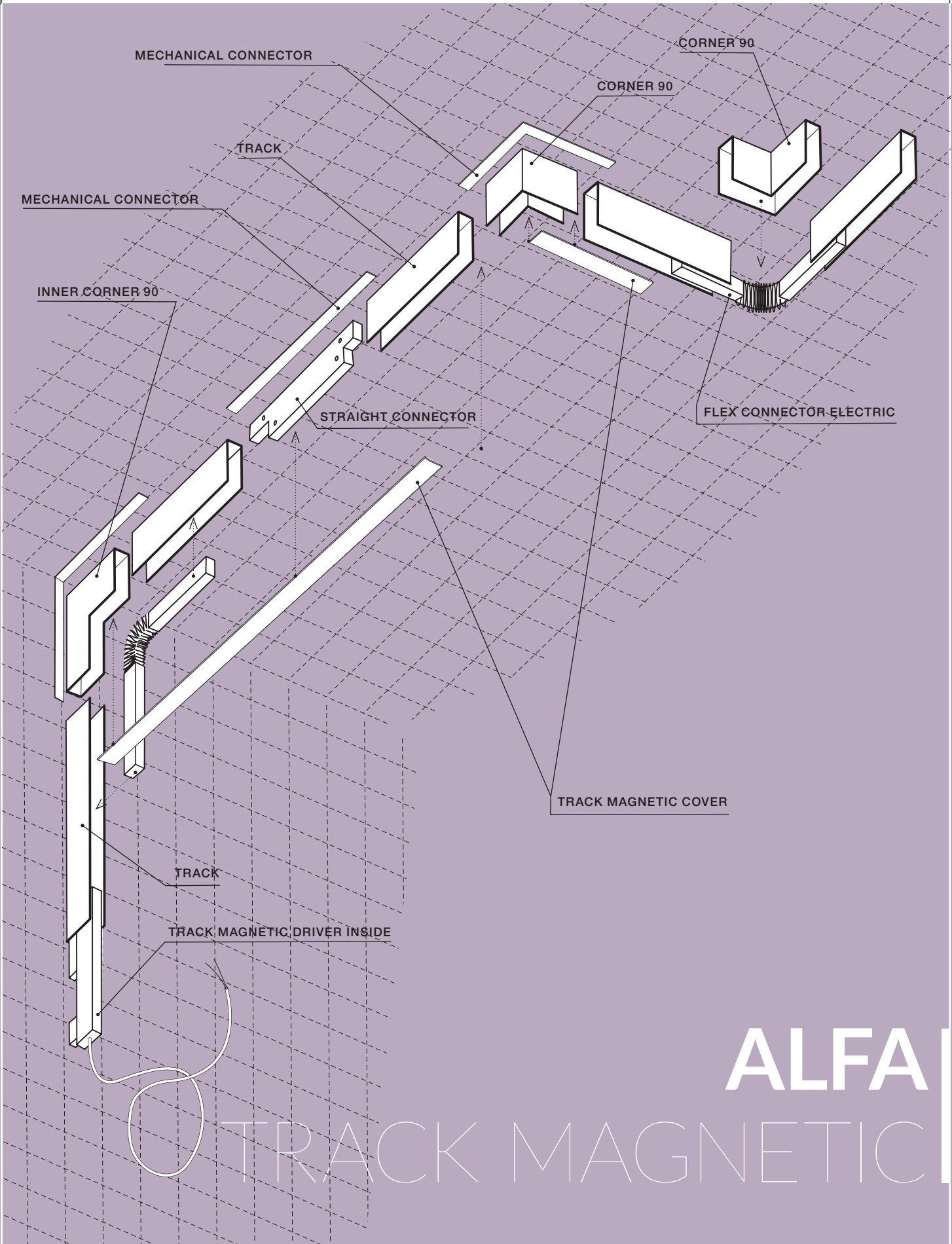

**ALFA**

TRACK MAGNETIC

# ALFA

track Magnetic

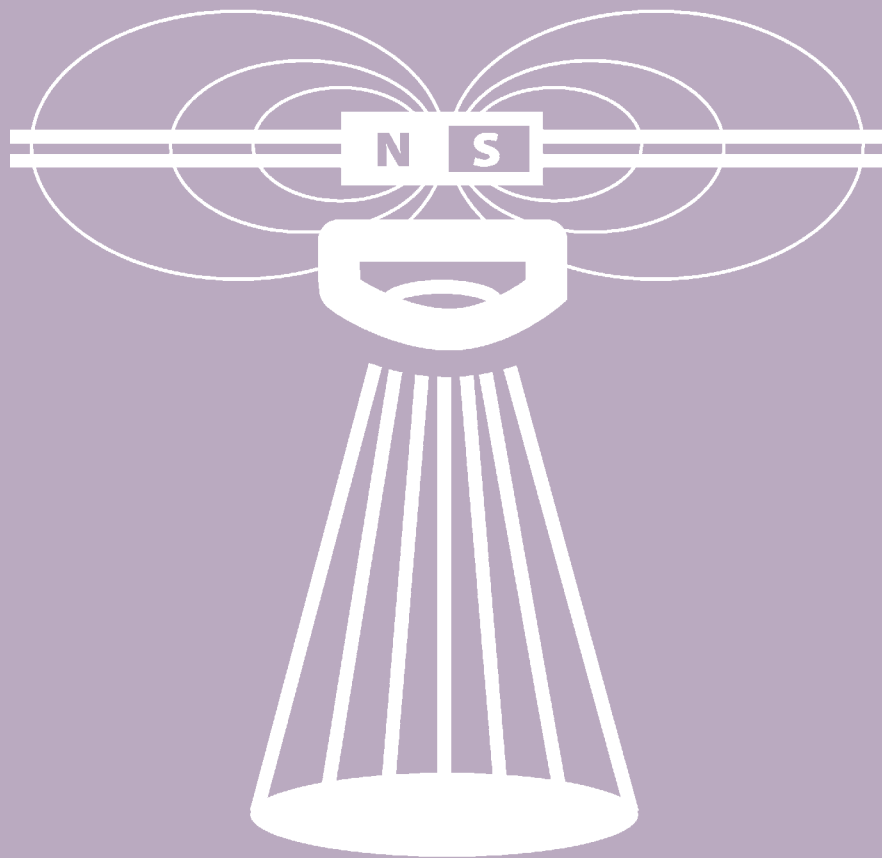

# ALFA TRACK MAGNETIC

## Example of the connection between track

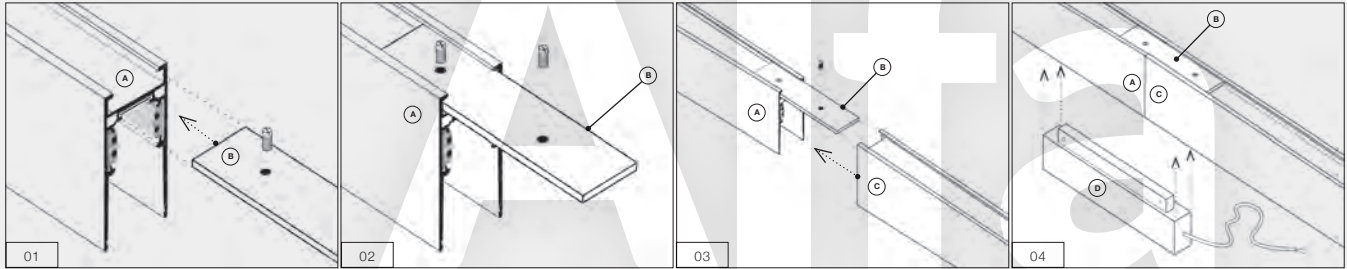

01 Insert the MECHANICAL CONNECTOR (B) into the TRACK (A).

02 Tighten the screw between A and B.

03 Slide and fasten TRACK (C) to the MECHANICAL CONNECTOR (B).

04 Put STRAIGHT CONNECTOR ELECTRIC (D) between the two connected tracks (A+C).

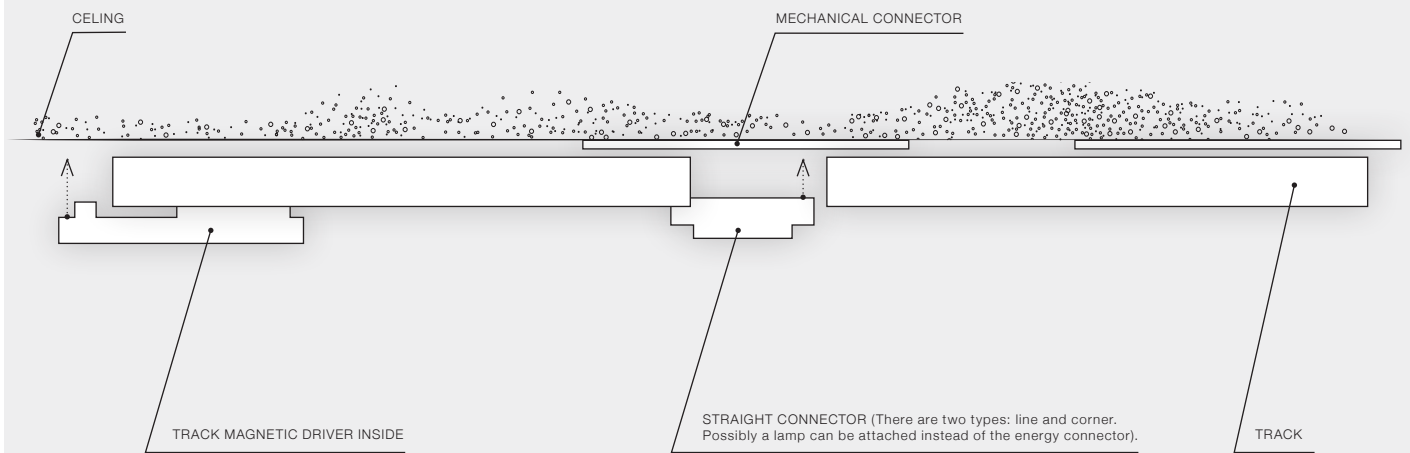

### ALFA Track Magnetic 27 (1m, 1,5m, 2m, 3m) WITH END CAP 2x (All included)

- ALFA TRACK MAGNETIC 27 1m (BLACK) ..... **AZ4713**
- ALFA TRACK MAGNETIC 27 1m (WHITE) ..... **AZ4712**
- ALFA TRACK MAGNETIC 27 1,5m (BLACK) ..... **AZ4715**
- ALFA TRACK MAGNETIC 27 1,5m (WHITE) ..... **AZ4714**
- ALFA TRACK MAGNETIC 27 2m (BLACK) ..... **AZ4717**
- ALFA TRACK MAGNETIC 27 2m (WHITE) ..... **AZ4716**
- ALFA TRACK MAGNETIC 27 3m (BLACK) ..... **AZ4719**
- ALFA TRACK MAGNETIC 27 3m (WHITE) ..... **AZ4718**

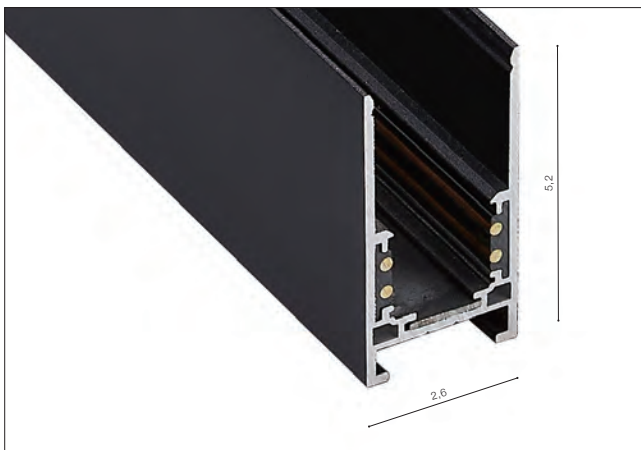

### ALFA Track Magnetic 52 (1m, 1,5m, 2m, 3m) WITH END CAP 2x (All included)

- ALFA TRACK MAGNETIC 52 1m (BLACK) ..... **AZ4638**
- ALFA TRACK MAGNETIC 52 1m (WHITE) ..... **AZ4639**
- ALFA TRACK MAGNETIC 52 1,5m (BLACK) ..... **AZ4640**
- ALFA TRACK MAGNETIC 52 1,5m (WHITE) ..... **AZ4641**
- ALFA TRACK MAGNETIC 52 2m (BLACK) ..... **AZ4642**
- ALFA TRACK MAGNETIC 52 2m (WHITE) ..... **AZ4643**
- ALFA TRACK MAGNETIC 52 3m (BLACK) ..... **AZ4644**
- ALFA TRACK MAGNETIC 52 3m (WHITE) ..... **AZ4645**

Available options for installation place – surface-mounted, flush-mounted and suspended

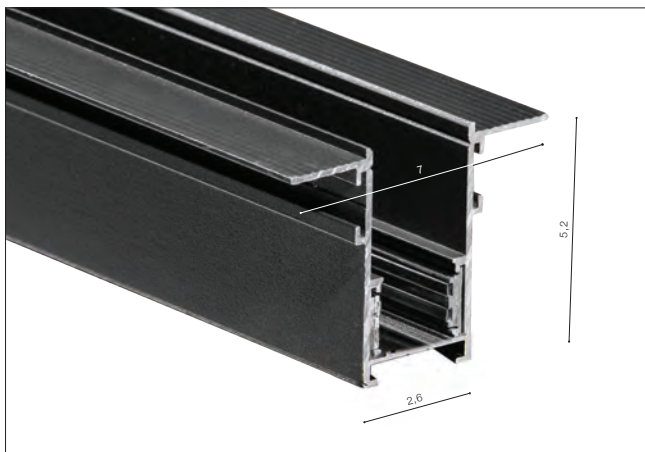
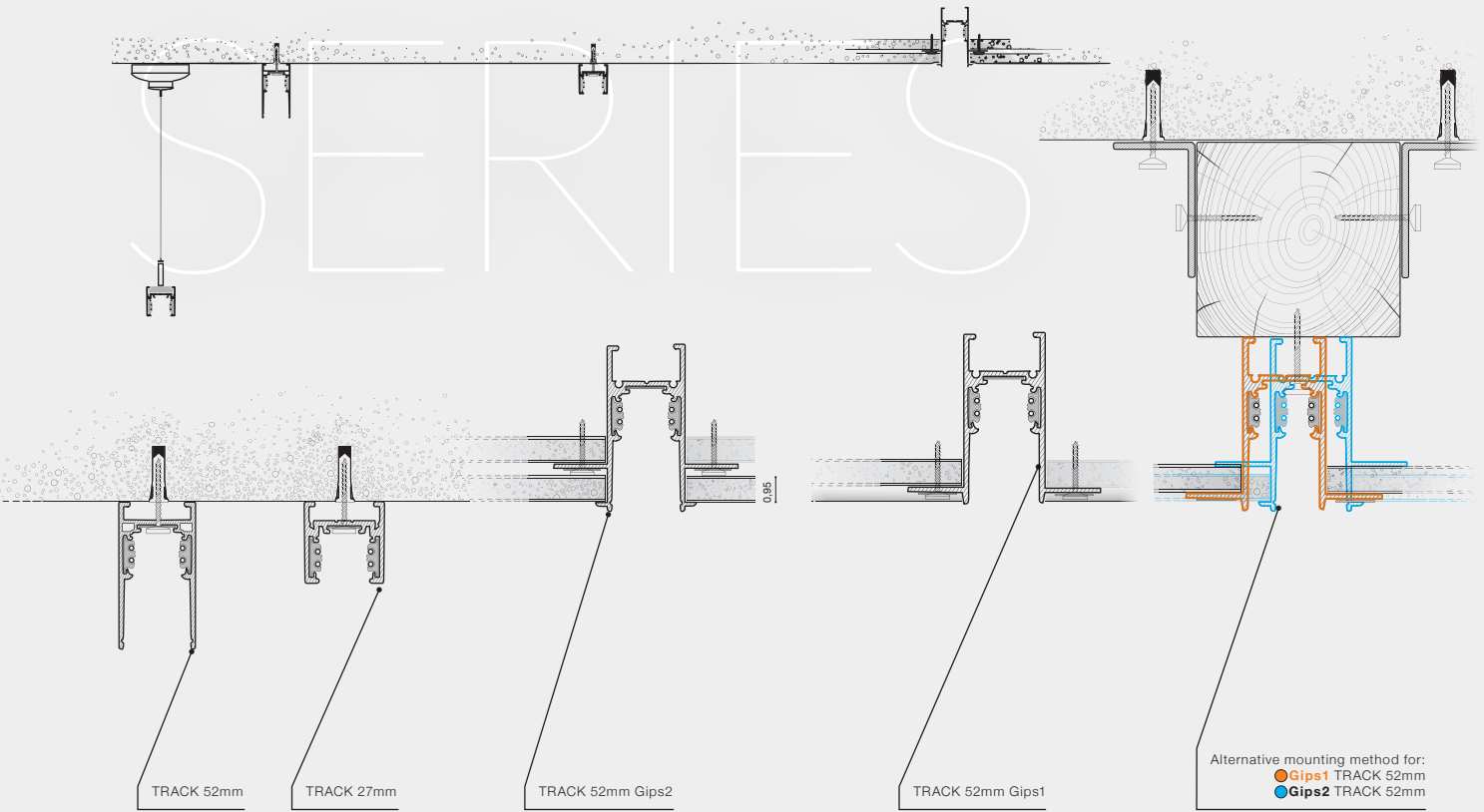

**ALFA Track Magnetic 52 Gips1 (1m, 1,5m, 2m, 3m)  
WITH END CAP 2x (All included)**

- ALFA TRACK MAGNETIC 52 GIPS1 1m (BLACK) . . . . . **AZ4863**
- ALFA TRACK MAGNETIC 52 GIPS1 1m (WHITE) . . . . . **AZ5457**
- ALFA TRACK MAGNETIC 52 GIPS1 1,5m (BLACK) . . . . . **AZ4864**
- ALFA TRACK MAGNETIC 52 GIPS1 1,5m (WHITE) . . . . . **AZ5458**
- ALFA TRACK MAGNETIC 52 GIPS1 2m (BLACK) . . . . . **AZ4865**
- ALFA TRACK MAGNETIC 52 GIPS1 2m (WHITE) . . . . . **AZ5453**
- ALFA TRACK MAGNETIC 52 GIPS1 3m (BLACK) . . . . . **AZ5455**
- ALFA TRACK MAGNETIC 52 GIPS1 3m (WHITE) . . . . . **AZ5454**

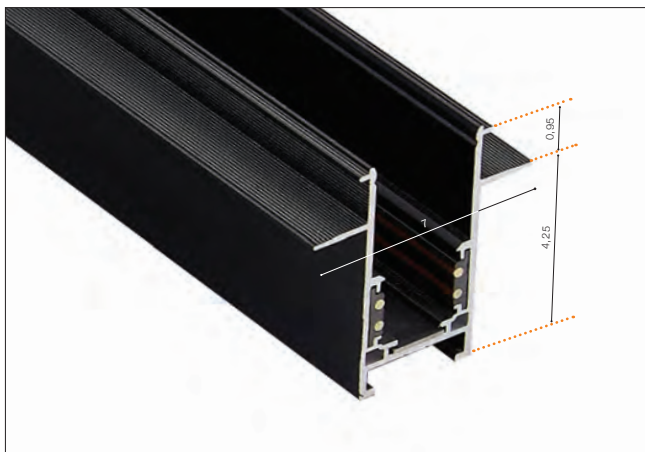

**ALFA Track Magnetic 52 Gips2 (1m, 1,5m, 2m)  
WITH END CAP 2x (All included)**

- ALFA TRACK MAGNETIC 52 GIPS2 1m (BLACK) . . . . . **AZ4646**
- ALFA TRACK MAGNETIC 52 GIPS2 1m (WHITE) . . . . . **AZ4647**
- ALFA TRACK MAGNETIC 52 GIPS2 1,5m (BLACK) . . . . . **AZ4648**
- ALFA TRACK MAGNETIC 52 GIPS2 1,5m (WHITE) . . . . . **AZ4649**
- ALFA TRACK MAGNETIC 52 GIPS2 2m (BLACK) . . . . . **AZ4650**
- ALFA TRACK MAGNETIC 52 GIPS2 2m (WHITE) . . . . . **AZ4651**



# ALFA TRACK MAGNETIC

76 Accesories for ALFA Track Magnetic



**ALFA Track Magnetic 52 Corner90 B**  
SURFACE CORNER 90° B

- ALFA TRACK MAGNETIC 52 CORNER 90 B (BLACK) ..... **AZ4683**
- ALFA TRACK MAGNETIC 52 CORNER 90 B (WHITE) ..... **AZ4684**



**ALFA Track Magnetic 52 Corner90 A**

- ALFA TRACK MAGNETIC 52 CORNER90 A (BLACK) ..... **AZ4679**
- ALFA TRACK MAGNETIC 52 CORNER90 A (WHITE) ..... **AZ4680**

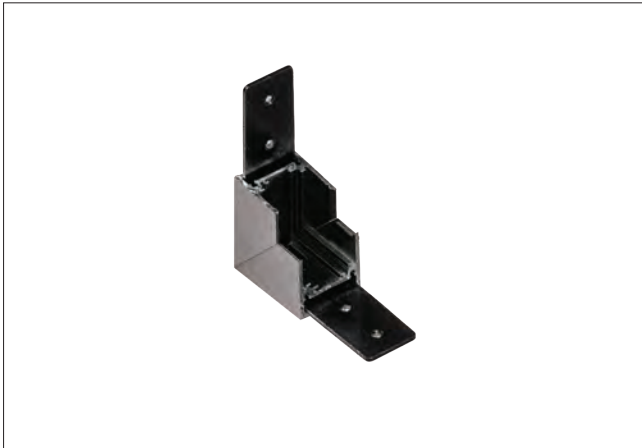
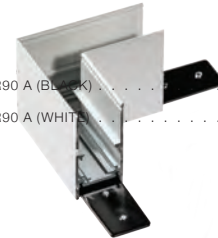

**ALFA Track Magnetic 27 Corner90 B**

- ALFA TRACK MAGNETIC 27 CORNER 90 B (BLACK) ..... **AZ5001**
- ALFA TRACK MAGNETIC 27 CORNER 90 B (WHITE) ..... **AZ5002**



**ALFA Track Magnetic 27 Corner90 A**

- ALFA TRACK MAGNETIC 27 CORNER 90 A (BLACK) ..... **AZ5003**
- ALFA TRACK MAGNETIC 27 CORNER 90 A (WHITE) ..... **AZ5004**

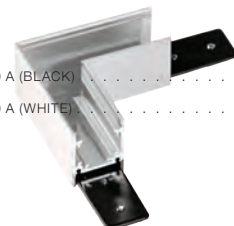



**ALFA Track Magnetic 52 Gips2 Corner90 B**  
SURFACE CORNER 90° B

- ALFA TRACK MAGNETIC 52 GIPS2 CORNER90 B (BLACK) . . . . . **AZ4685**
- ALFA TRACK MAGNETIC 52 GIPS2 CORNER90 B (WHITE) . . . . . **AZ4686**

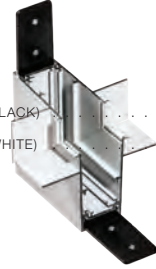

**ALFA Track Magnetic 52 Gips2 Corner90 A**  
SURFACE CORNER 90° A

- ALFA TRACK MAGNETIC 52 GIPS2 CORNER90 A (BLACK) . . . . . **AZ4681**
- ALFA TRACK MAGNETIC 52 GIPS2 CORNER90 A (WHITE) . . . . . **AZ4682**



**ALFA Track Magnetic 52 Gips1 Corner90 B**  
SURFACE CORNER 90° B

- ALFA TRACK MAGNETIC 52 GIPS1 CORNER90 B (BLACK) . . . . . **AZ5463**
- ALFA TRACK MAGNETIC 52 GIPS1 CORNER90 B (WHITE) . . . . . **AZ5462**

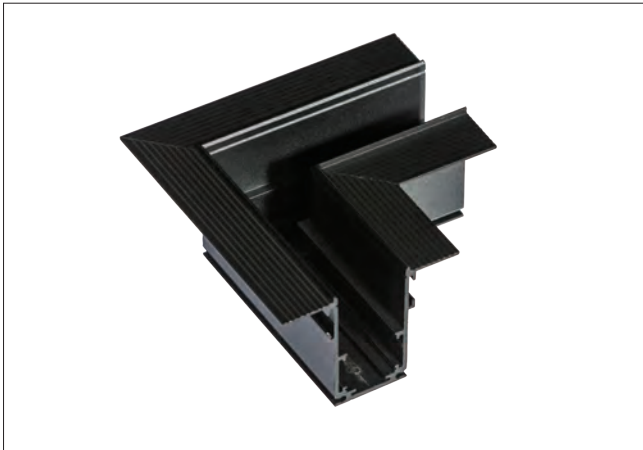

**ALFA Track Magnetic 52 Gips1 Corner90 A**  
SURFACE CORNER 90° A

- ALFA TRACK MAGNETIC 52 GIPS1 CORNER90 A (BLACK) . . . . . **AZ4862**
- ALFA TRACK MAGNETIC 52 GIPS1 CORNER90 A (WHITE) . . . . . **AZ5461**

# ALFA TRACK MAGNETIC

78 Accessories for ALFA Track Magnetic

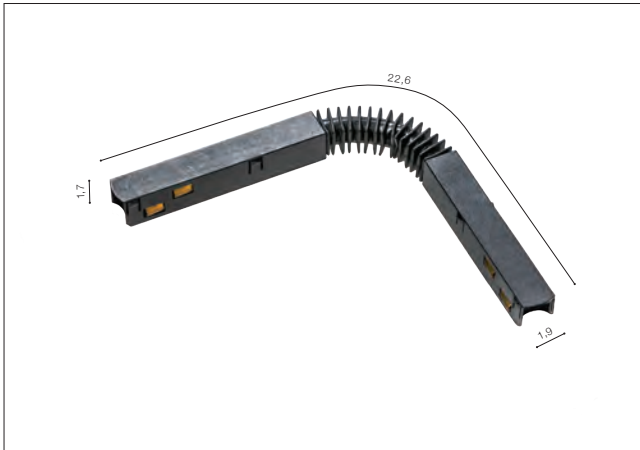

## ALFA Track Magnetic Flex Connector Electric

- ALFA TRACK MAGNETIC FLEX CONNECTOR ELECTRIC (BLACK) . . . . . **AZ4687**
- ALFA TRACK MAGNETIC FLEX CONNECTOR ELECTRIC (WHITE) . . . . . **AZ4688**

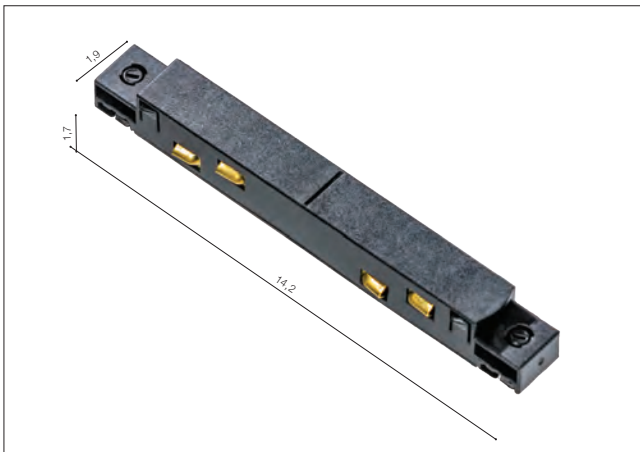

## ALFA Track Magnetic Straight Connector

- ALFA TRACK MAGNETIC STRAGHT CONNECTOR (BLACK) . . . . . **AZ4677**
- ALFA TRACK MAGNETIC STRAGHT CONNECTOR (WHITE) . . . . . **AZ4678**



## ALFA Track Magnetic Mechanical Connector

- ALFA TRACK MAGNETIC MECHANICAL CONNECTOR (BLACK) . . . . . **AZ4689**
- ALFA TRACK MAGNETIC MECHANICAL CONNECTOR (WHITE) . . . . . **AZ4690**

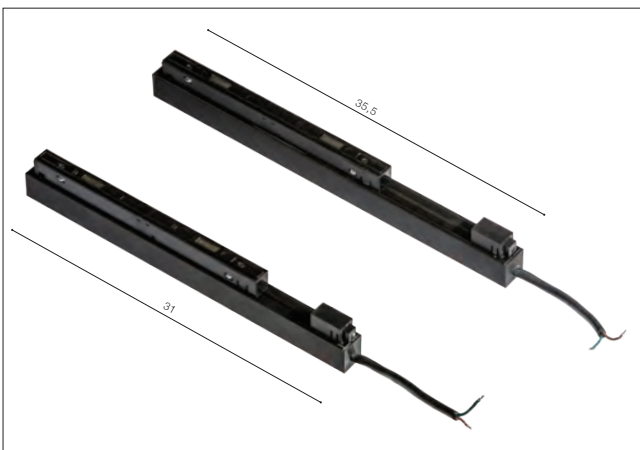
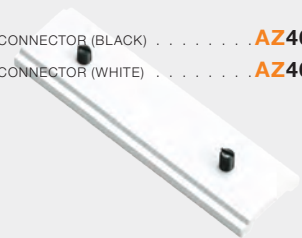

## ALFA TRACK MAGNETIC DRIVER INSIDE (60W, 100W, 200W)

- ALFA TRACK MAGNETIC DRIVER INSIDE 60W (BLACK) . . . . . **AZ4669**
- ALFA TRACK MAGNETIC DRIVER INSIDE 60W (WHITE) . . . . . **AZ4670**
- ALFA TRACK MAGNETIC DRIVER INSIDE 100W (BLACK) . . . . . **AZ4671**
- ALFA TRACK MAGNETIC DRIVER INSIDE 100W (WHITE) . . . . . **AZ4672**
- ALFA TRACK MAGNETIC DRIVER INSIDE 200W (BLACK) . . . . . **AZ4673**
- ALFA TRACK MAGNETIC DRIVER INSIDE 200W (WHITE) . . . . . **AZ4674**

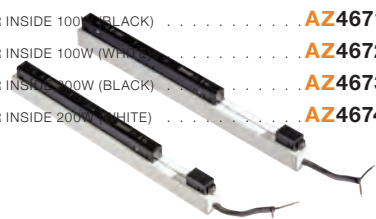





**TRACK MAGNETIC DRIVER MEANWELL 48V  
100W / 200W / 350W**

THIS DRIVER IS UNIVERSAL FOR SYSTEMS:  
ALFA, GAMMA, NEO

- TRACK MAGNETIC DRIVER MEANWELL (100W) . . . . . **AZ4691**
- TRACK MAGNETIC DRIVER MEANWELL (200W) . . . . . **AZ4692**
- TRACK MAGNETIC DRIVER MEANWELL (350W) . . . . . **AZ4866**

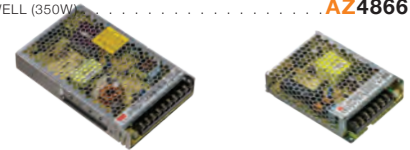

**ALFA Track Magnetic Driver Electric Connector**

- ALFA TRACK MAGNETIC DRIVER ELECTRIC CONNECTOR (BLACK) . . . . . **AZ4675**
- ALFA TRACK MAGNETIC DRIVER ELECTRIC CONNECTOR (WHITE) . . . . . **AZ4676**



**ALFA Track Magnetic 27 Cover  
Power Driver Inside**

- ALFA TRACK MAGNETIC 27 COVER (BLACK) . . . . . **AZ4860**
- ALFA TRACK MAGNETIC 27 COVER (WHITE) . . . . . **AZ4861**

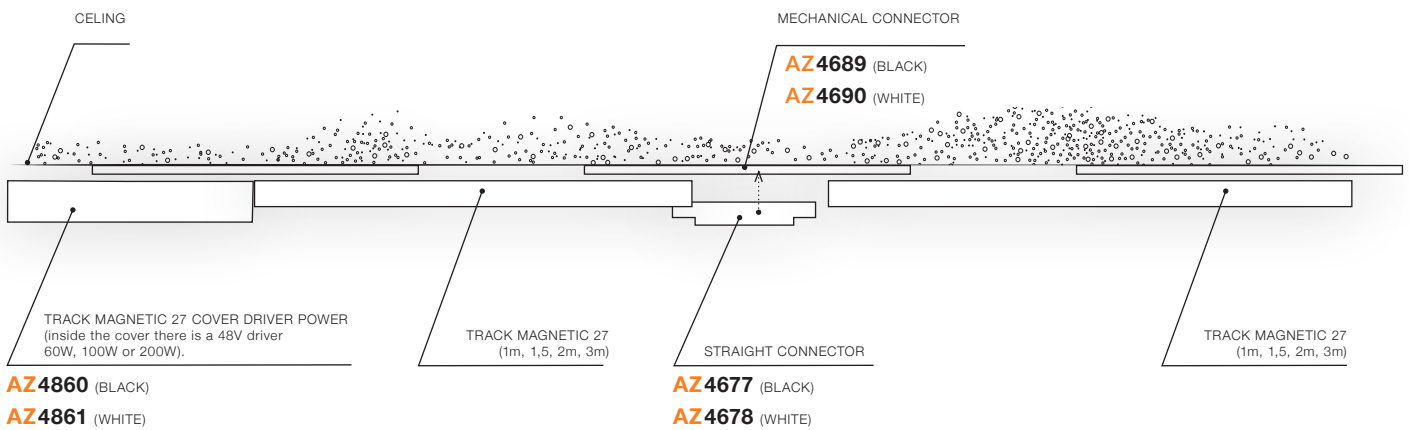

# ALFA TRACK MAGNETIC



## ALFA Track Magnetic Suspension Kit 2m

- ALFA TRACK MAGNETIC SUSPENSION KIT 2m (BLACK) ..... **AZ4693**
- ALFA TRACK MAGNETIC SUSPENSION KIT 2m (WHITE) ..... **AZ4694**

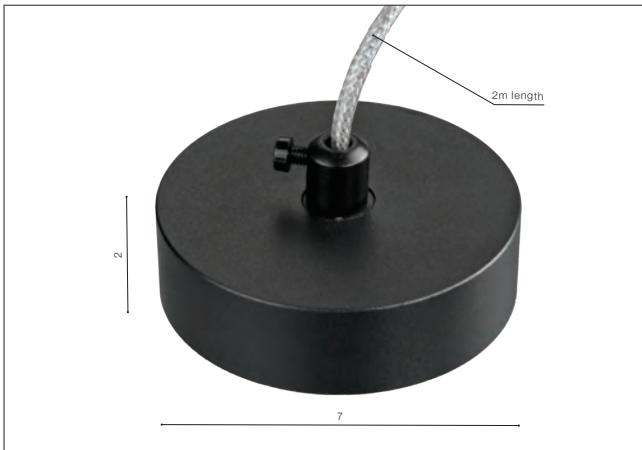

## Ceiling Plate + Wire

- TRACK CEILING PLATE + WIRE (BLACK) ..... **AZ4780**
- TRACK CEILING PLATE + WIRE (WHITE) ..... **AZ4782**

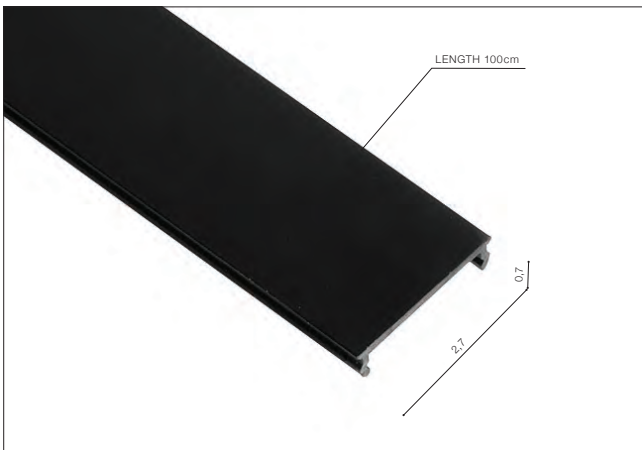

## ALFA Track Magnetic 52 Cover 1m

- ALFA TRACK MAGNETIC 52 COVER 1m (BLACK) ..... **AZ4652**
- ALFA TRACK MAGNETIC 52 COVER 1m (WHITE) ..... **AZ4653**

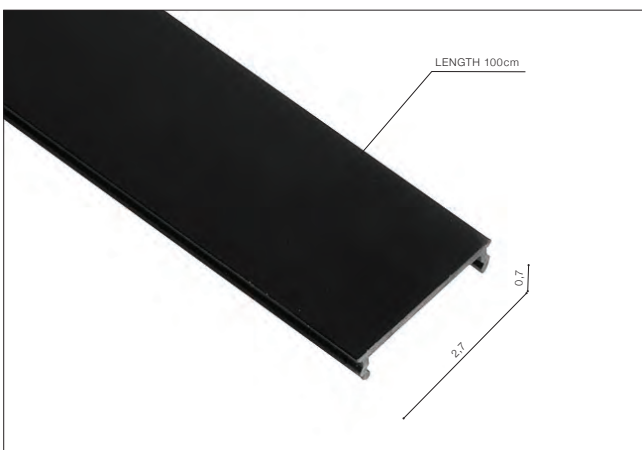
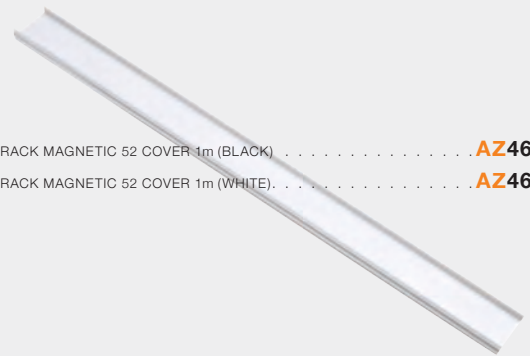

## ALFA Track Magnetic 27 Cover 1m

- ALFA TRACK MAGNETIC 27 COVER 1m (BLACK) ..... **AZ5444**
- ALFA TRACK MAGNETIC 27 COVER 1m (WHITE) ..... **AZ5443**

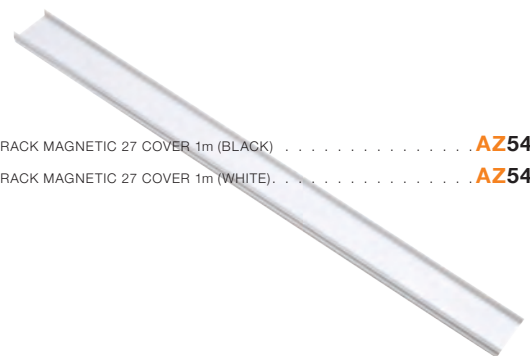

The Bluetooth gateway connects to the Internet via the WiFi signal from the router, thanks to which you can remotely control the lamps or devices settings via the AzzardoSMART application. Being at home, you can control the devices using a special AzzardoSMART remote control or from any device (phone, tablet, computer) that has access to the Wifi network.

**Bluetooth Gateway Smart**

AZ4856

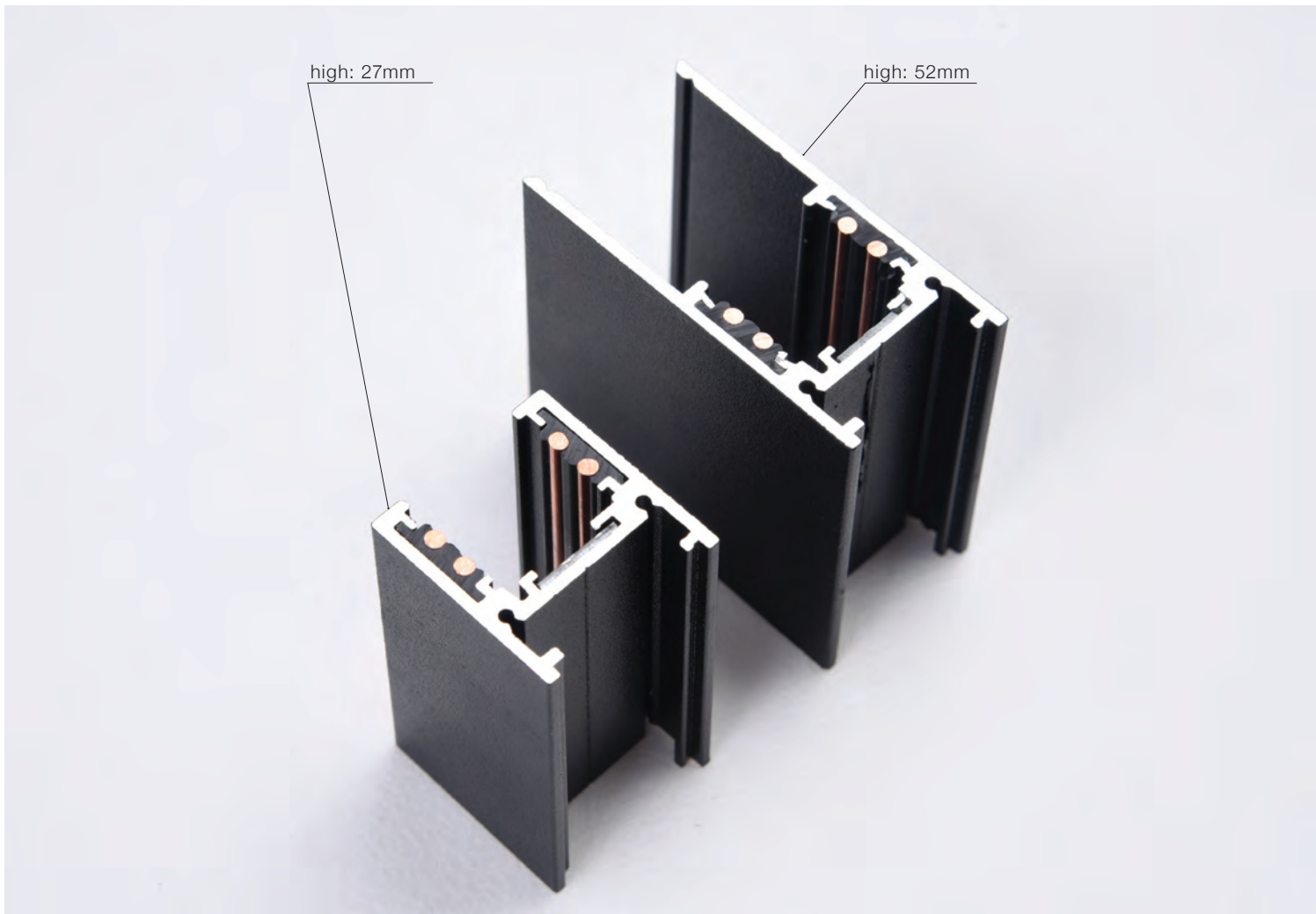
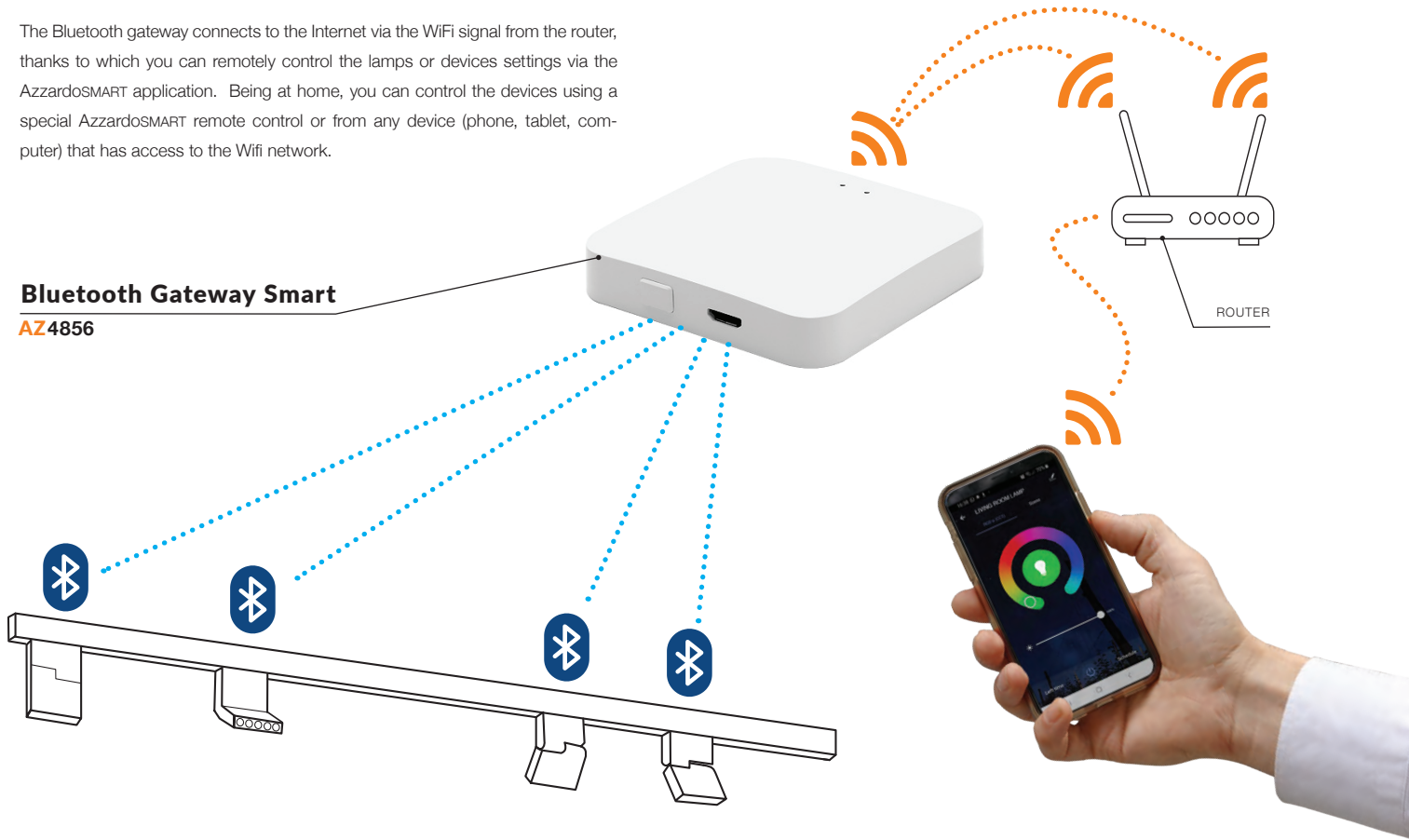

# REMOTE CONTROL BLUETOOTH

## Remote Control 4-Group & RGB & Bluetooth Operating Schematic

AZ5265

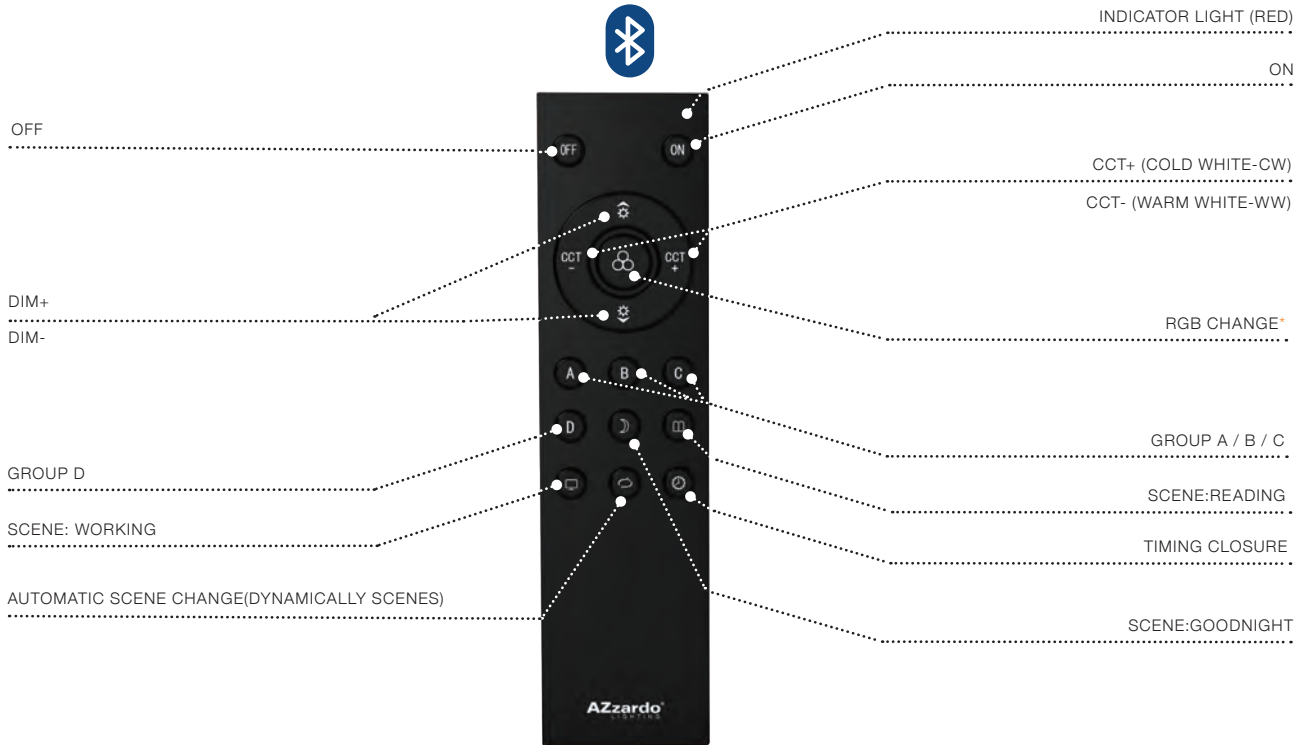

\*RGB CHANGE ONLY USED FOR RGB LAMPS  
THE CCT LAMP CAN'T BE USE THIS BUTTON FUNCTION

## Remote Control 3 Group Operating Schematic

AZ4857

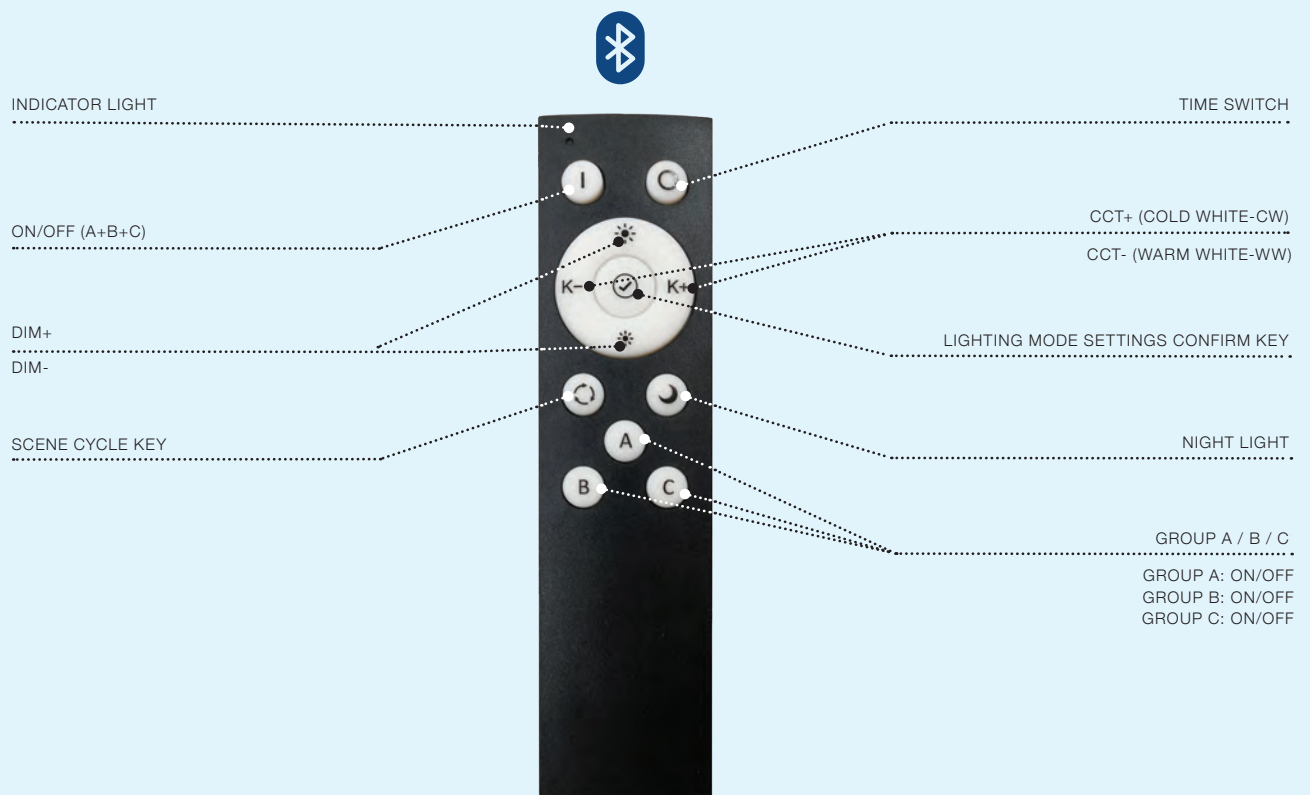

Switch Panel Remote Control 2-Group Bluetooth Bk

Operating Schematic

AZ5209

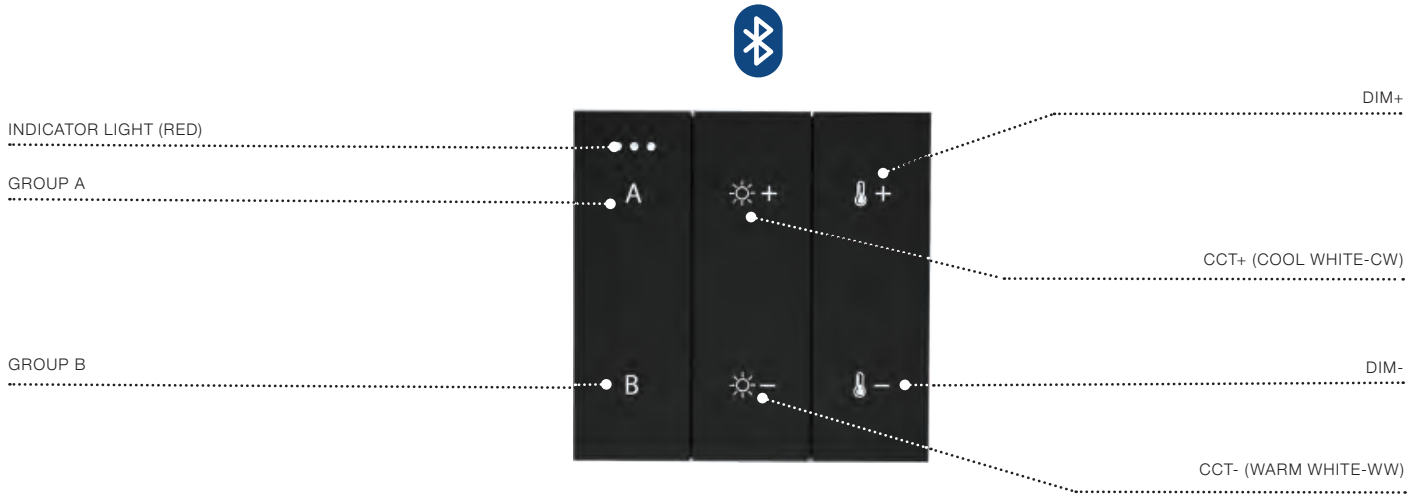

Switch Panel Remote Control 2-Group Bluetooth

SWITCH PANEL REMOTE CONTROL 2-GROUP BLUETOOTH (WH) . . . . . AZ5210

DOWNLOAD THE APP



STANDARD

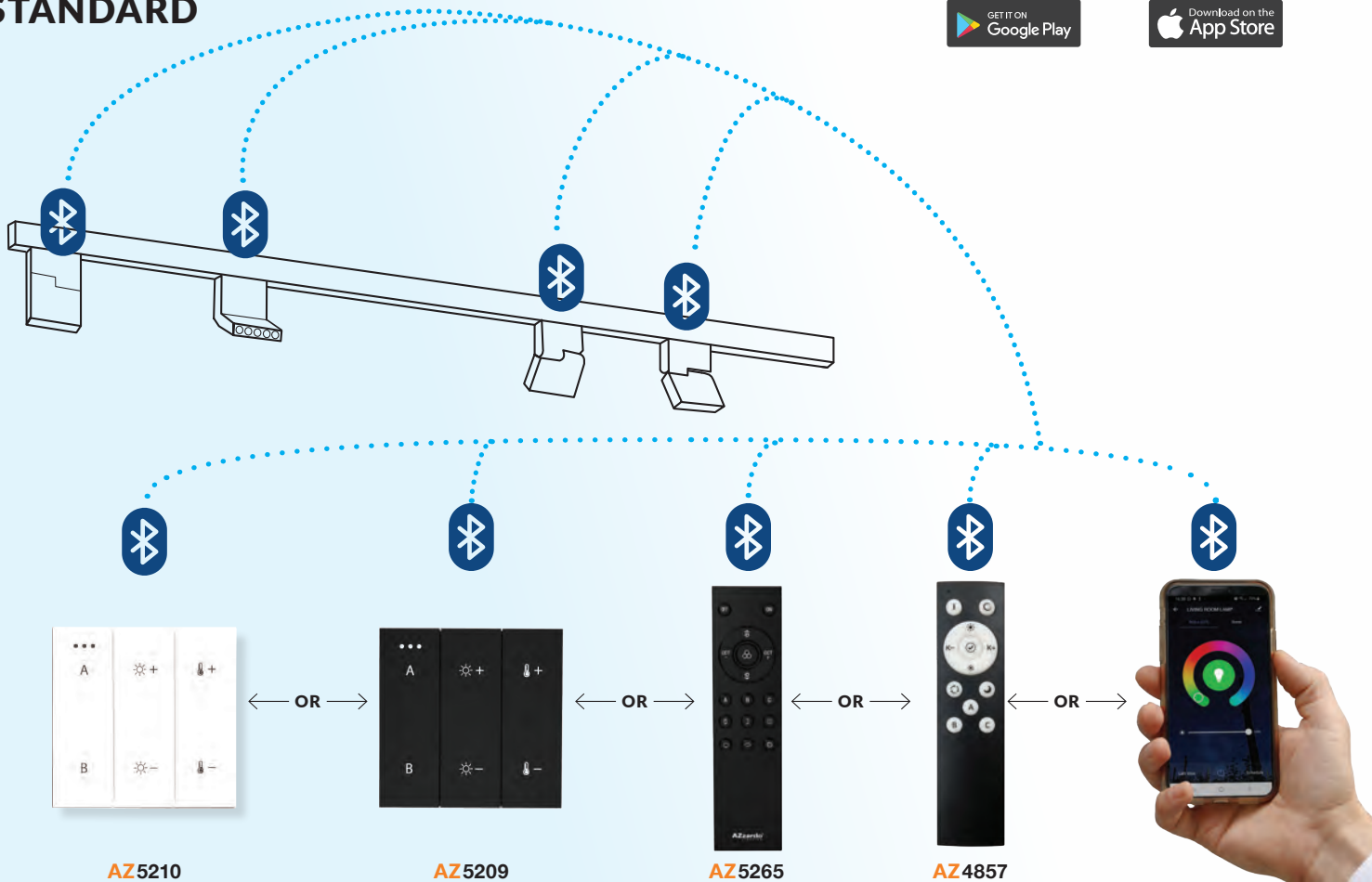

AZ5210

AZ5209

AZ5265

AZ4857

# ALFA MAKITA TRACK MAGNETIC CCT BLUETOOTH

84 Track Magnetic System - ALFA



BK

## ALFA MAKITA TRACK MAGNETIC 7W CCT BLUETOOTH

LED integrated

voltage: 48V

IP20

technical specification

LED 7W 550lm CCT

installation: ALFA Track Magnetic - 52 or 27

beam angle: 40°

COLOUR / NEW INDEX NO.

SAND BLACK (BK) . . . . . **AZ4836**

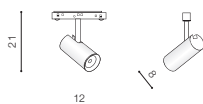

BK

## ALFA MAKITA 2 TRACK MAGNETIC 2X 7W CCT BLUETOOTH

LED integrated

voltage: 48V

IP20

technical specification

LED 2x 7W 550lm CCT

installation: ALFA Track Magnetic - 52 or 27

beam angle: 40°

COLOUR / NEW INDEX NO.

SAND BLACK (BK) . . . . . **AZ4838**

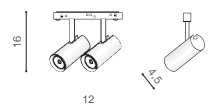

# ALFA MAKITA TRACK MAGNETIC CCT BLUETOOTH



BK

## ALFA MAKITA TRACK MAGNETIC 20W CCT BLUETOOTH

LED integrated

voltage: 48V

LED 20W 1560lm CCT

**LED**

IP20



technical specification

installation: ALFA Track Magnetic - 52 or 27

beam angle: 40°

COLOUR / NEW INDEX NO.

■ SAND BLACK (BK) . . . . . **AZ4840**

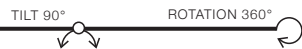
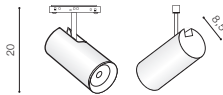

BK

## ALFA MAKITA TRACK MAGNETIC 30W CCT BLUETOOTH

LED integrated

voltage: 48V

LED 30W 2340lm CCT

**LED**

IP20



technical specification

installation: ALFA Track Magnetic - 52 or 27

beam angle: 40°

COLOUR / NEW INDEX NO.

■ SAND BLACK (BK) . . . . . **AZ4842**

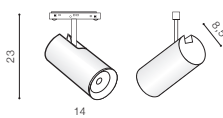

# ALFA SAGA TRACK MAGNETIC CCT BLUETOOTH

86 Track Magnetic System - ALFA

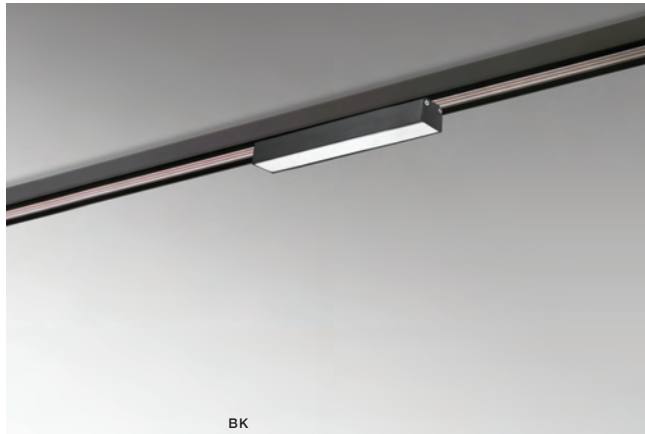

BK

**ALFA SAGA TRACK MAGNETIC 12W**  
 CCT BLUETOOTH LED integrated

voltage: 48V	LED 12W 600lm CCT	
IP20		
technical specification		installation: ALFA Track Magnetic - 52 or 27 <input type="checkbox"/>
		beam angle: 120° <input type="checkbox"/>

COLOUR / NEW INDEX NO.

■ SAND BLACK (BK) . . . . . **AZ4846**



BK

**ALFA SAGA TRACK MAGNETIC 20W**  
 CCT BLUETOOTH LED integrated

voltage: 48V	LED 20W 1100lm CCT	
IP20		
technical specification		installation: ALFA Track Magnetic - 52 or 27 <input type="checkbox"/>
		beam angle: 120° <input type="checkbox"/>

COLOUR / NEW INDEX NO.

■ SAND BLACK (BK) . . . . . **AZ4848**



BK

**ALFA SAGA TRACK MAGNETIC 36W**  
 CCT BLUETOOTH LED integrated

voltage: 48V	LED 36W 1900lm CCT	
IP20		
technical specification		installation: ALFA Track Magnetic - 52 or 27 <input type="checkbox"/>
		beam angle: 120° <input type="checkbox"/>

COLOUR / NEW INDEX NO.

■ SAND BLACK (BK) . . . . . **AZ4850**

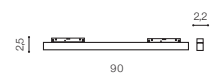



# ALFA SONYA TRACK MAGNETIC CCT BLUETOOTH

Track Magnetic System - ALFA 87



## ALFA SONYA TRACK MAGNETIC CCT BLUETOOTH

LED integrated

voltage: 48V

IP20

technical specification



LED 20W 2100lm CCT

**LED**

installation: ALFA Track Magnetic - 52 or 27

beam angle: 60°

COLOUR / NEW INDEX NO.

SAND BLACK (BK) . . . . . **AZ4844**

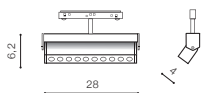

# ALFA KERRY TRACK MAGNETIC CCT BLUETOOTH

88 Track Magnetic System - ALFA



**ALFA KERRY TRACK MAGNETIC 5W**  
CCT BLUETOOTH LED integrated

voltage: 48V	LED 5W 550lm CCT		
IP20	installation: ALFA Track Magnetic - 52 or 27		
technical specification	beam angle: 40°		

**ALFA KERRY TRACK MAGNETIC 15W**  
CCT BLUETOOTH LED integrated

voltage: 48V	LED 15W 1220lm CCT		
IP20	installation: ALFA Track Magnetic - 52 or 27		
technical specification	beam angle: 60°		

COLOUR / NEW INDEX NO.  
 SAND BLACK (BK) . . . . . **AZ4852**

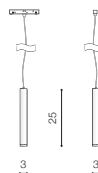

COLOUR / NEW INDEX NO.  
 SAND BLACK (BK) . . . . . **AZ4854**

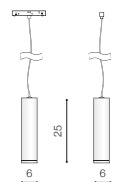

# ALFA KIRA TRACK MAGNETIC CCT BLUETOOTH

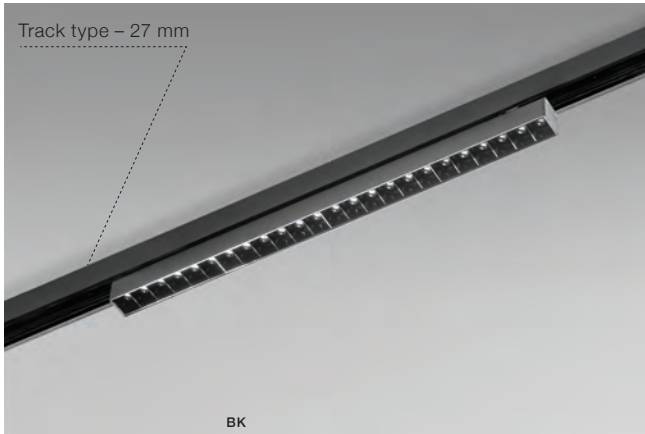

**ALFA KIRA TRACK MAGNETIC 12W**  
CCT BLUETOOTH LED integrated

voltage: 48V	LED 12W 1150lm		
IP20	installation: ALFA Track Magnetic – 52 or 27		
technical specification	beam angle: 50°		

COLOUR / NEW INDEX NO.

BLACK (BK) . . . . . **AZ4901**

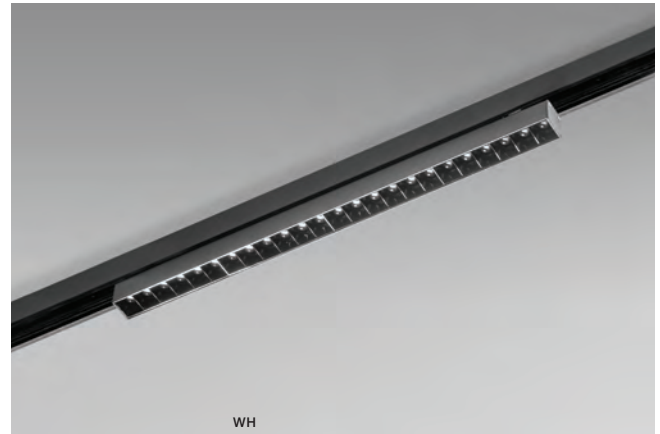

**ALFA KIRA TRACK MAGNETIC 20W**  
CCT BLUETOOTH LED integrated

voltage: 48V	LED 24W 1450lm		
IP20	installation: ALFA Track Magnetic – 52 or 27		
technical specification	beam angle: 50°		

COLOUR / NEW INDEX NO.

BLACK (BK) . . . . . **AZ4902**

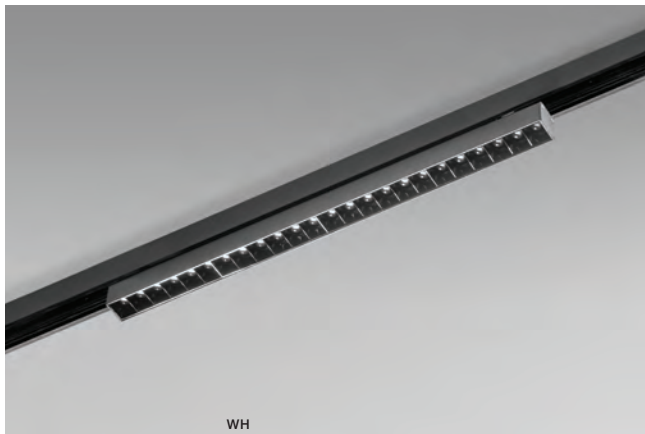

**ALFA KIRA TRACK MAGNETIC 30W**  
CCT BLUETOOTH LED integrated

voltage: 48V	LED 24W 1750lm		
IP20	installation: ALFA Track Magnetic – 52 or 27		
technical specification	beam angle: 50°		

COLOUR / NEW INDEX NO.

BLACK (BK) . . . . . **AZ4903**



SYSTEM COMPONENTS NAMES FOR TRACK 3-LINE SYSTEM

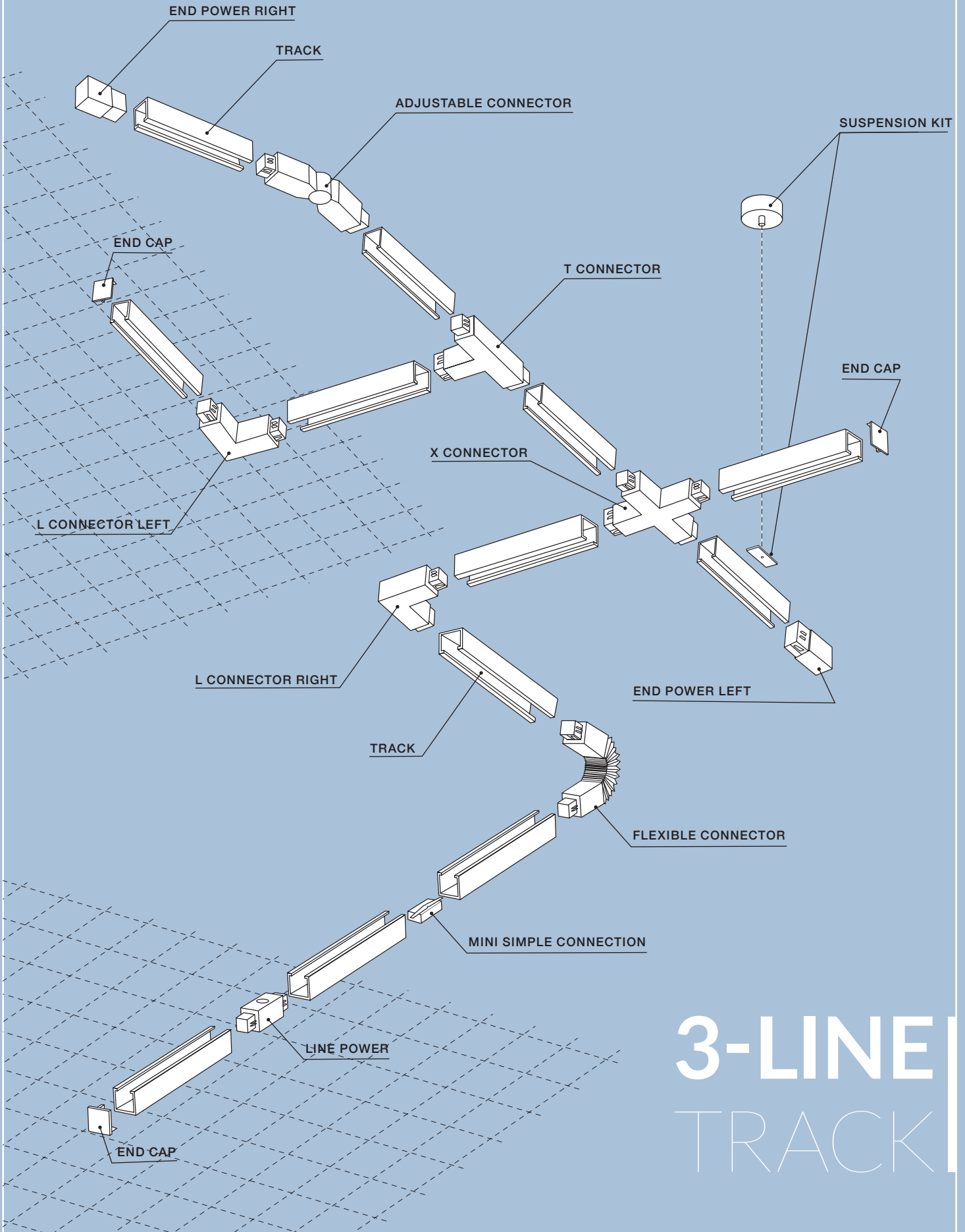

# 3 - LINE

track 3-Line

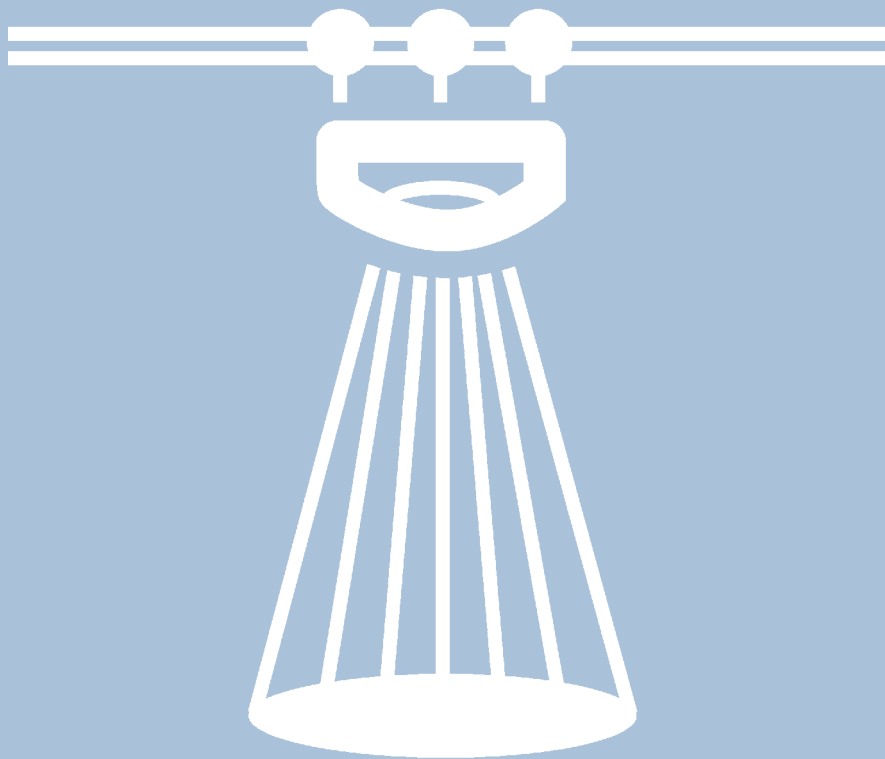

# TRACK 3-LINE

# 3-Li

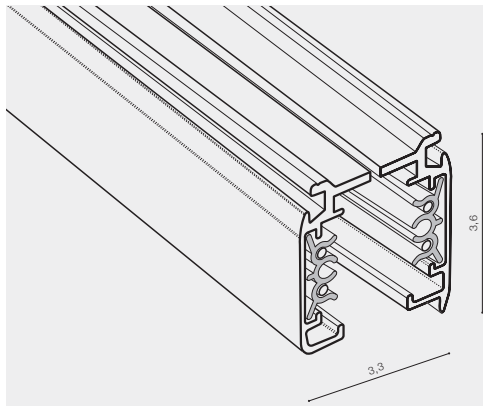

Example of the connection between track

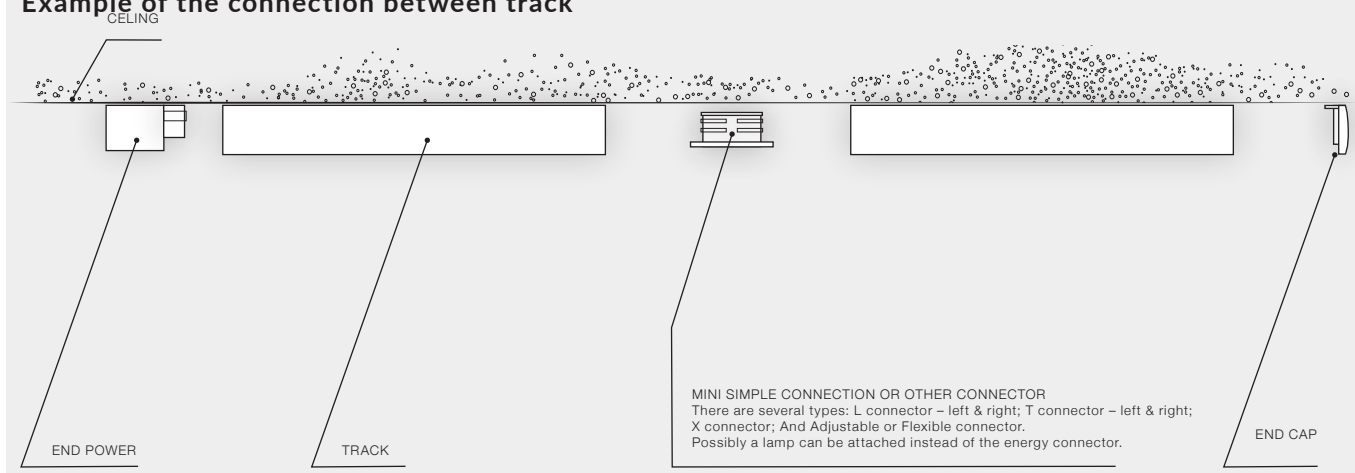

## TRACKS (1m, 1,5m, 2m, 3m)

- |                                     |                              |               |
|-------------------------------------|------------------------------|---------------|
| <input checked="" type="checkbox"/> | TRACK 1M (BLACK) . . . . .   | <b>AZ2973</b> |
| <input type="checkbox"/>            | TRACK 1M (WHITE) . . . . .   | <b>AZ2974</b> |
| <input checked="" type="checkbox"/> | TRACK 1,5M (BLACK) . . . . . | <b>AZ3000</b> |
| <input type="checkbox"/>            | TRACK 1,5M (WHITE) . . . . . | <b>AZ2999</b> |
| <input checked="" type="checkbox"/> | TRACK 2M (BLACK) . . . . .   | <b>AZ2975</b> |
| <input type="checkbox"/>            | TRACK 2M (WHITE) . . . . .   | <b>AZ2976</b> |
| <input checked="" type="checkbox"/> | TRACK 3M (BLACK) . . . . .   | <b>AZ4272</b> |
| <input type="checkbox"/>            | TRACK 3M (WHITE) . . . . .   | <b>AZ4271</b> |

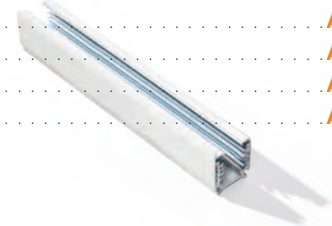

## Track Set (1m, 1,5m, 2m)

with THE END POWER + END CAP (All included)

- |                                     |                                  |               |
|-------------------------------------|----------------------------------|---------------|
| <input checked="" type="checkbox"/> | TRACK SET 1M (BLACK) . . . . .   | <b>AZ2987</b> |
| <input type="checkbox"/>            | TRACK SET 1M (WHITE) . . . . .   | <b>AZ2991</b> |
| <input checked="" type="checkbox"/> | TRACK SET 1,5M (BLACK) . . . . . | <b>AZ3001</b> |
| <input type="checkbox"/>            | TRACK SET 1,5M (WHITE) . . . . . | <b>AZ3002</b> |
| <input checked="" type="checkbox"/> | TRACK SET 2M (BLACK) . . . . .   | <b>AZ2992</b> |
| <input type="checkbox"/>            | TRACK SET 2M (WHITE) . . . . .   | <b>AZ2988</b> |

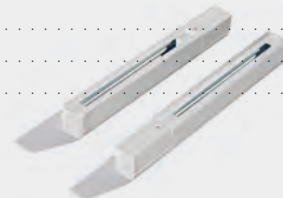

Available options for installation place – surface-mounted, flush-mounted and suspended

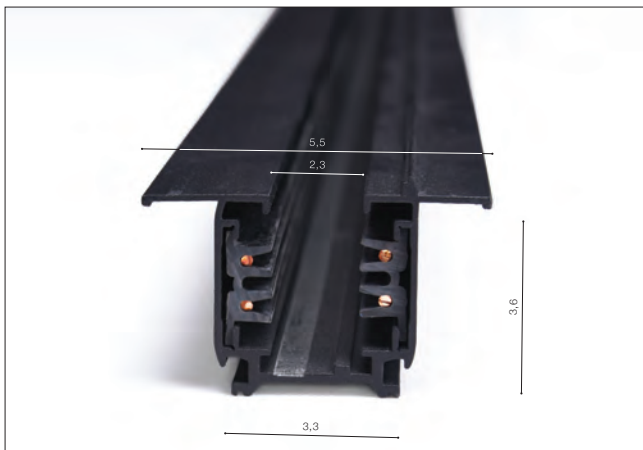
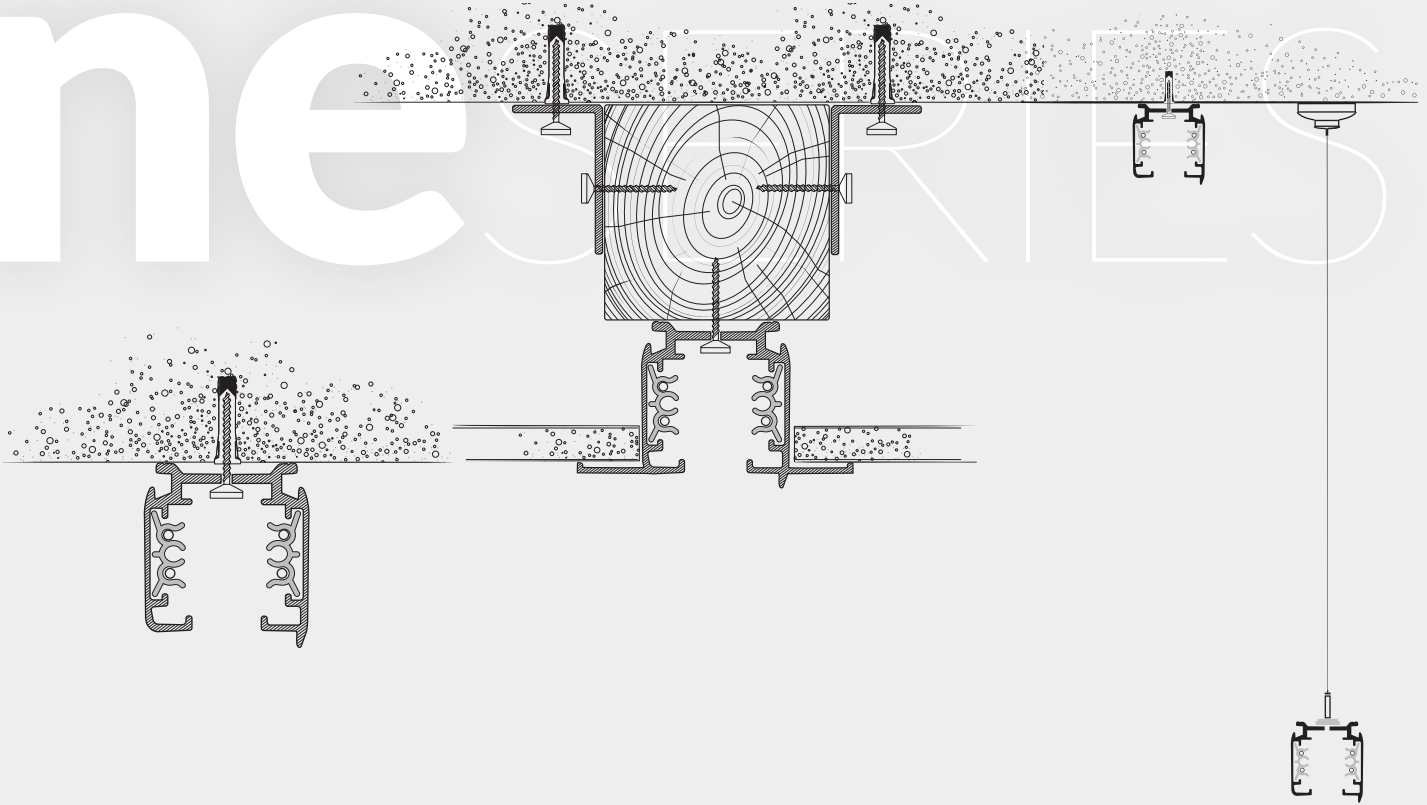

**TRACKS GIPS (1m, 2m, 3m)**

- TRACK GIPS 1m (BLACK) . . . . . **AZ4290**
- TRACK GIPS 1m (WHITE) . . . . . **AZ4289**
- TRACK GIPS 2m (BLACK) . . . . . **AZ4292**
- TRACK GIPS 2m (WHITE) . . . . . **AZ4291**
- TRACK GIPS 3m (BLACK) . . . . . **AZ4294**
- TRACK GIPS 3m (WHITE) . . . . . **AZ4293**



**MINI SIMPLE CONNECTION**

- MINI SIMPLE CONNECTION (BLACK) . . . . . **AZ2981**
- MINI SIMPLE CONNECTION (WHITE) . . . . . **AZ2982**



# EIGER TRACK 3 LINE

94 Track 3 Line



## EIGER TRACK 3 LINE GU10

bulb not included

voltage: 230V	GU10 1x Max. 50W	
IP20	installation: Track 3 Line	



### COLOUR / NEW INDEX NO.

- BLACK (BK) . . . . . **AZ4205**
- BLACK / GOLD (BK/GO) . . . . . **AZ4206**
- WHITE (WH) . . . . . **AZ4204**
- GOLD (GO) . . . . . **AZ5238**

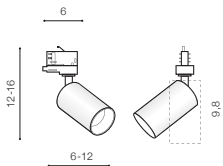



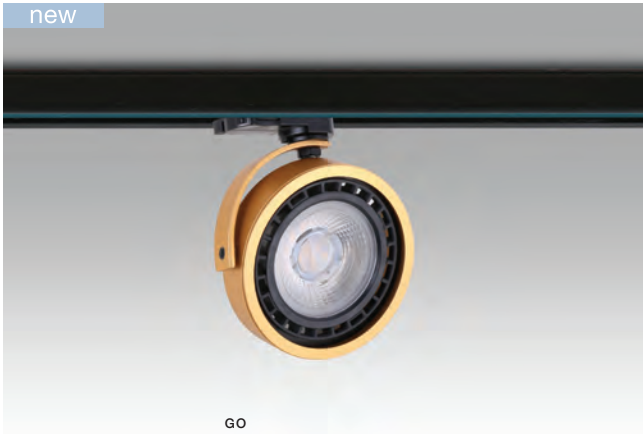

GO

**JERRY TRACK 3 LINE ES111**

bulb not included

voltage: 230V	connect 1x ES111 MAX 50W
IP20	installation place: track 3 x line

COLOUR / NEW INDEX NO.

- GOLD (GO) . . . . . **AZ5237**
- WHITE (WH). . . . . **AZ2459**
- BLACK (BK). . . . . **AZ2458**

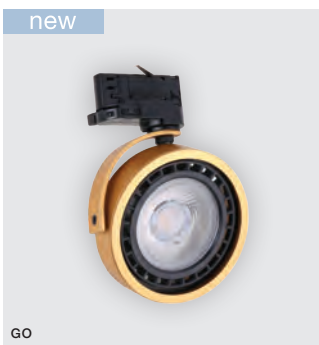
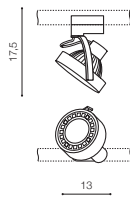

GO



WH

BK





**AZzardo**<sup>®</sup>

TECHNOLINE

[www.azzardolighting.com](http://www.azzardolighting.com)



# EXPOSED DOWNLIGHTS

# EXPOSED

downlights

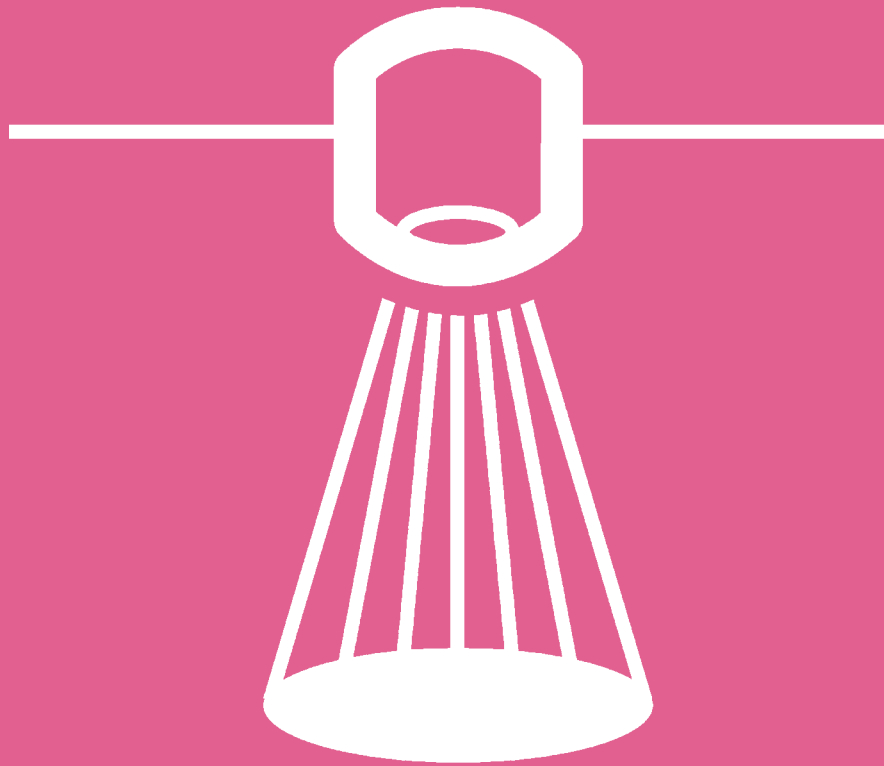

# ARO IP54

100 Exposed downlights



**ARO IP54**

voltage: 230V		GU10 x 1xMAX 35W	bulb not included <input checked="" type="checkbox"/>
IP54		installation place	<input type="checkbox"/>



COLOUR / NEW INDEX NO.

- GOLD (GO) . . . . . **AZ5240**
- CHROME (CH) . . . . . **AZ1360**
- WHITE (WH) . . . . . **AZ2559**
- BLACK (BK) . . . . . **AZ2558**

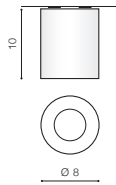



**EIGER IP54**

bulb not included

voltage: 230V	GU10 x 1xMAX 50W
IP54	instalation place

COLOUR / NEW INDEX NO.

- GOLD (GO) . . . . . **AZ5239**
- BLACK (BK) . . . . . **AZ4260**
- BLACK / GOLD (BK/GO) . . . . . **AZ4261**
- WHITE (WH) . . . . . **AZ4259**



RECOMMENDED FOR DROPPED CEILING

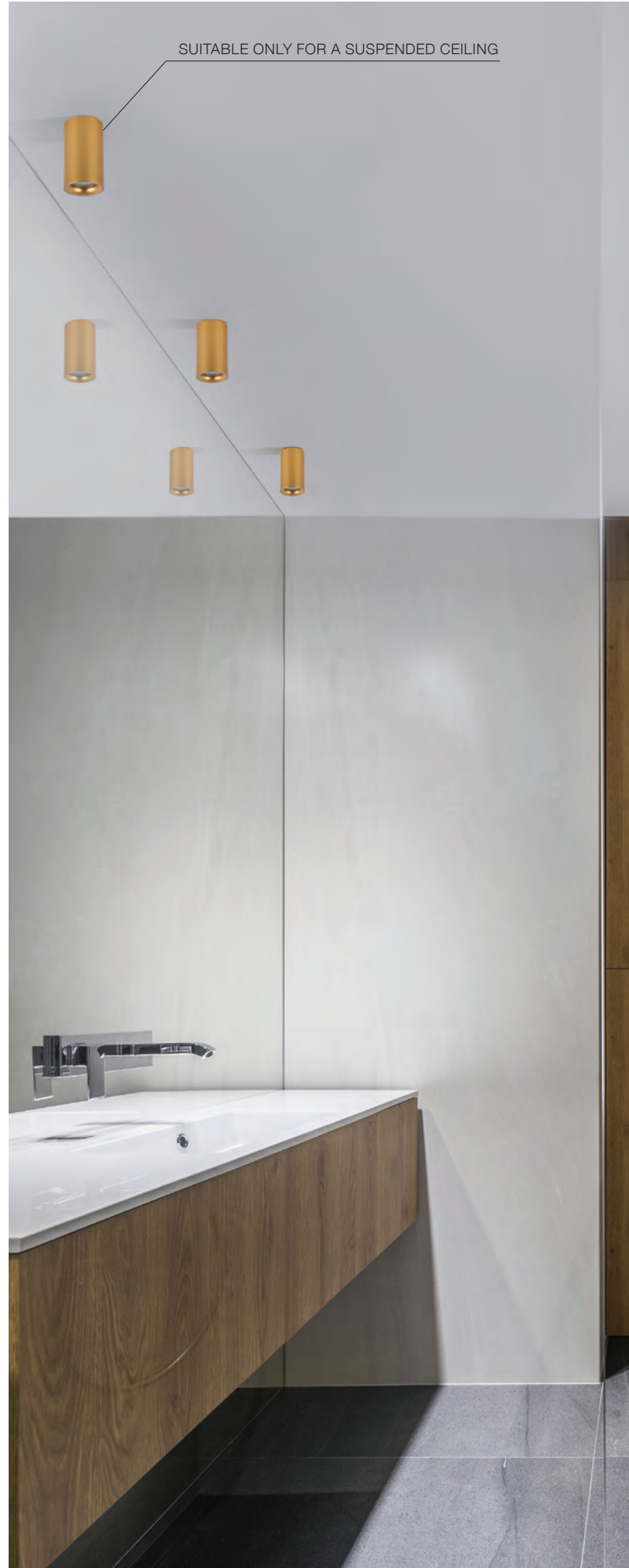

# PANKA CCT SWITCH SENSOR

102 Exposed downlights



**PANKA 18 CCT SWITCH SENSOR**

LED integrated

voltage: 230V	LED 12W 780lm		<b>LED</b>
IP40	2800K/4000K/6000K		
technical specification	Installation place:	<input type="checkbox"/>	<input type="checkbox"/>
	beam angle: 120°	<input type="checkbox"/>	<input type="checkbox"/>

COLOUR / NEW INDEX NO.

- WHITE (WH) . . . . . **AZ5353**
- BLACK (BK) . . . . . **AZ5354**

2,4



18



**PANKA 23 CCT SWITCH SENSOR**

LED integrated

voltage: 230V	LED 18W 1170lm		<b>LED</b>
IP40	2800K/4000K/6000K		
technical specification	Installation place:	<input type="checkbox"/>	<input type="checkbox"/>
	beam angle: 120°	<input type="checkbox"/>	<input type="checkbox"/>

COLOUR / NEW INDEX NO.

- WHITE (WH) . . . . . **AZ5355**
- BLACK (BK) . . . . . **AZ5356**

2,4



23

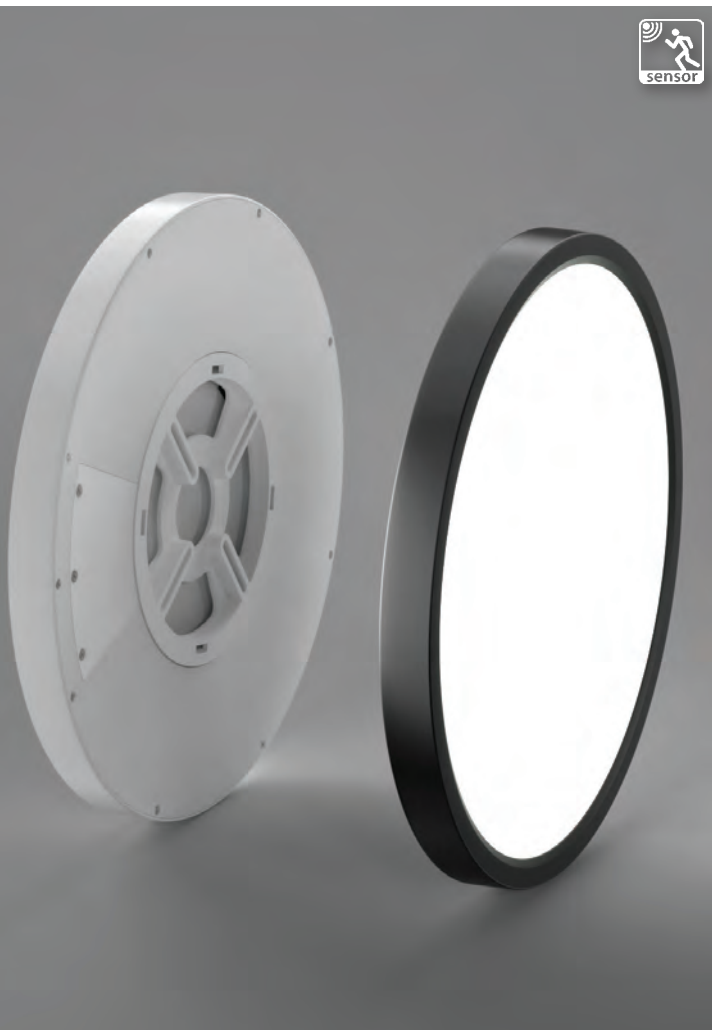

**PANKA 30 CCT SWITCH SENSOR**

LED integrated

voltage: 230V	LED 24W 1560lm		<b>LED</b>
IP40	2800K/4000K/6000K		
technical specification	Installation place:	<input type="checkbox"/>	<input type="checkbox"/>
	beam angle: 120°	<input type="checkbox"/>	<input type="checkbox"/>

COLOUR / NEW INDEX NO.

- WHITE (WH) . . . . . **AZ5357**
- BLACK (BK) . . . . . **AZ5358**

2,4



30



# PANKA SQ CCT SWITCH SENSOR

Exposed downlights 103



PANKA SQ 23 CCT SWITCH SENSOR

LED integrated

voltage: 230V	LED 18W 1170lm		<b>LED</b>
IP40	2800K/4000K/6000K		
technical specification	Installation place:	<input type="checkbox"/>	<input type="checkbox"/>
	beam angle: 120°	<input type="checkbox"/>	<input type="checkbox"/>

COLOUR / NEW INDEX NO.

- WHITE (WH) . . . . . **AZ5359**
- BLACK (BK) . . . . . **AZ5360**

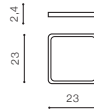

PANKA SQ 30 CCT SWITCH SENSOR

LED integrated

voltage: 230V	LED 24W 1560lm		<b>LED</b>
IP40	2800K/4000K/6000K		
technical specification	Installation place:	<input type="checkbox"/>	<input type="checkbox"/>
	beam angle: 120°	<input type="checkbox"/>	<input type="checkbox"/>

COLOUR / NEW INDEX NO.

- WHITE (WH) . . . . . **AZ5361**
- BLACK (BK) . . . . . **AZ5362**

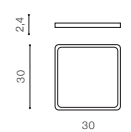

## MINIATURE MICROWAVE MOTION SENSOR

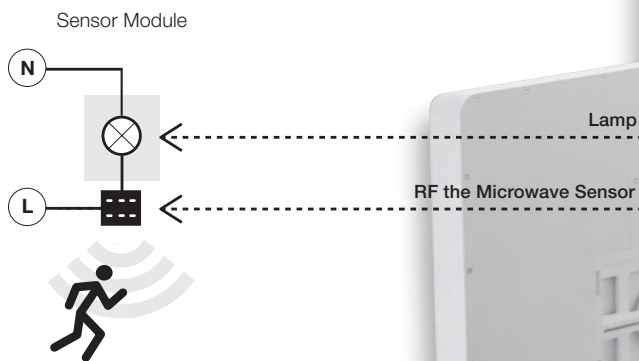

The default operating distance of the sensor is up to 5m. Lighting time up to 60sec

# PANKA CCT SWITCH DIMM

104 Exposed downlights



WH

## PANKA 23 CCT SWITCH DIMM

LED integrated

voltage: 230V	LED 18W 1170lm		
IP40	2800K/4000K/6000K dimm		
technical specification	Installation place:	<input type="checkbox"/>	<input type="checkbox"/>
	beam angle: 120°	<input type="checkbox"/>	<input type="checkbox"/>

COLOUR / NEW INDEX NO.

- WHITE (WH) . . . . . **AZ5363**
- BLACK (BK) . . . . . **AZ5364**



WH

## PANKA 30 CCT SWITCH DIMM

LED integrated

voltage: 230V	LED 24W 1560lm		
IP40	2800K/4000K/6000K dimm		
technical specification	Installation place:	<input type="checkbox"/>	<input type="checkbox"/>
	beam angle: 120°	<input type="checkbox"/>	<input type="checkbox"/>

COLOUR / NEW INDEX NO.

- WHITE (WH) . . . . . **AZ5365**
- BLACK (BK) . . . . . **AZ5366**

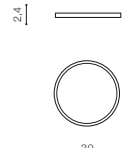

BK

## PANKA 40 CCT SWITCH DIMM

LED integrated

voltage: 230V	LED 32W 2080lm		
IP40	2800K/4000K/6000K dimm		
technical specification	Installation place:	<input type="checkbox"/>	<input type="checkbox"/>
	beam angle: 120°	<input type="checkbox"/>	<input type="checkbox"/>

COLOUR / NEW INDEX NO.

- WHITE (WH) . . . . . **AZ5367**
- BLACK (BK) . . . . . **AZ5368**

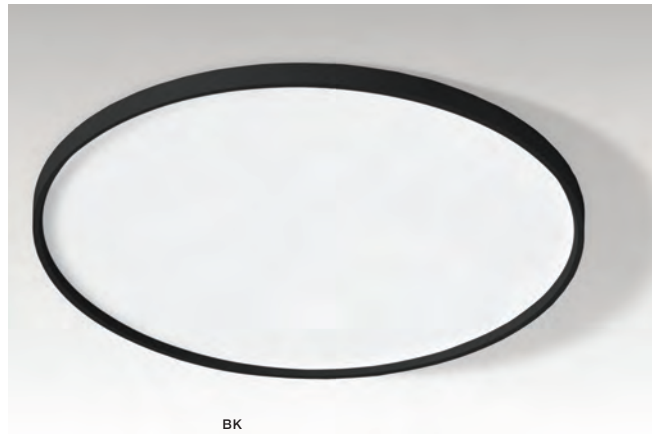
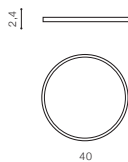

BK

## PANKA 60 CCT SWITCH DIMM

LED integrated

voltage: 230V	LED 45W 2925lm		
IP40	2800K/4000K/6000K dimm		
technical specification	Installation place:	<input type="checkbox"/>	<input type="checkbox"/>
	beam angle: 120°	<input type="checkbox"/>	<input type="checkbox"/>

COLOUR / NEW INDEX NO.

- WHITE (WH) . . . . . **AZ5369**
- BLACK (BK) . . . . . **AZ5370**

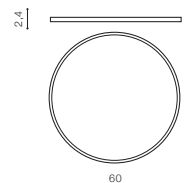

PANKA SQ CCT SWITCH DIMM



BK

PANKA SQ 30 CCT SWITCH DIMM

LED integrated

voltage: 230V	LED 24W 1560lm		LED
IP40	2800K/4000K/6000K dimm		
technical specification	Installation place:	<input type="checkbox"/>	<input type="checkbox"/>
	beam angle: 120°	<input type="checkbox"/>	<input type="checkbox"/>

COLOUR / NEW INDEX NO.

- WHITE (WH) . . . . . **AZ5371**
- BLACK (BK) . . . . . **AZ5372**

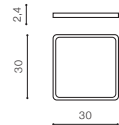

BK

PANKA SQ 45 CCT SWITCH DIMM

LED integrated

voltage: 230V	LED 45W 2925lm		LED
IP40	2800K/4000K/6000K dimm		
technical specification	Installation place:	<input type="checkbox"/>	<input type="checkbox"/>
	beam angle: 120°	<input type="checkbox"/>	<input type="checkbox"/>

COLOUR / NEW INDEX NO.

- WHITE (WH) . . . . . **AZ5373**
- BLACK (BK) . . . . . **AZ5374**

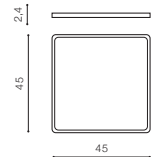

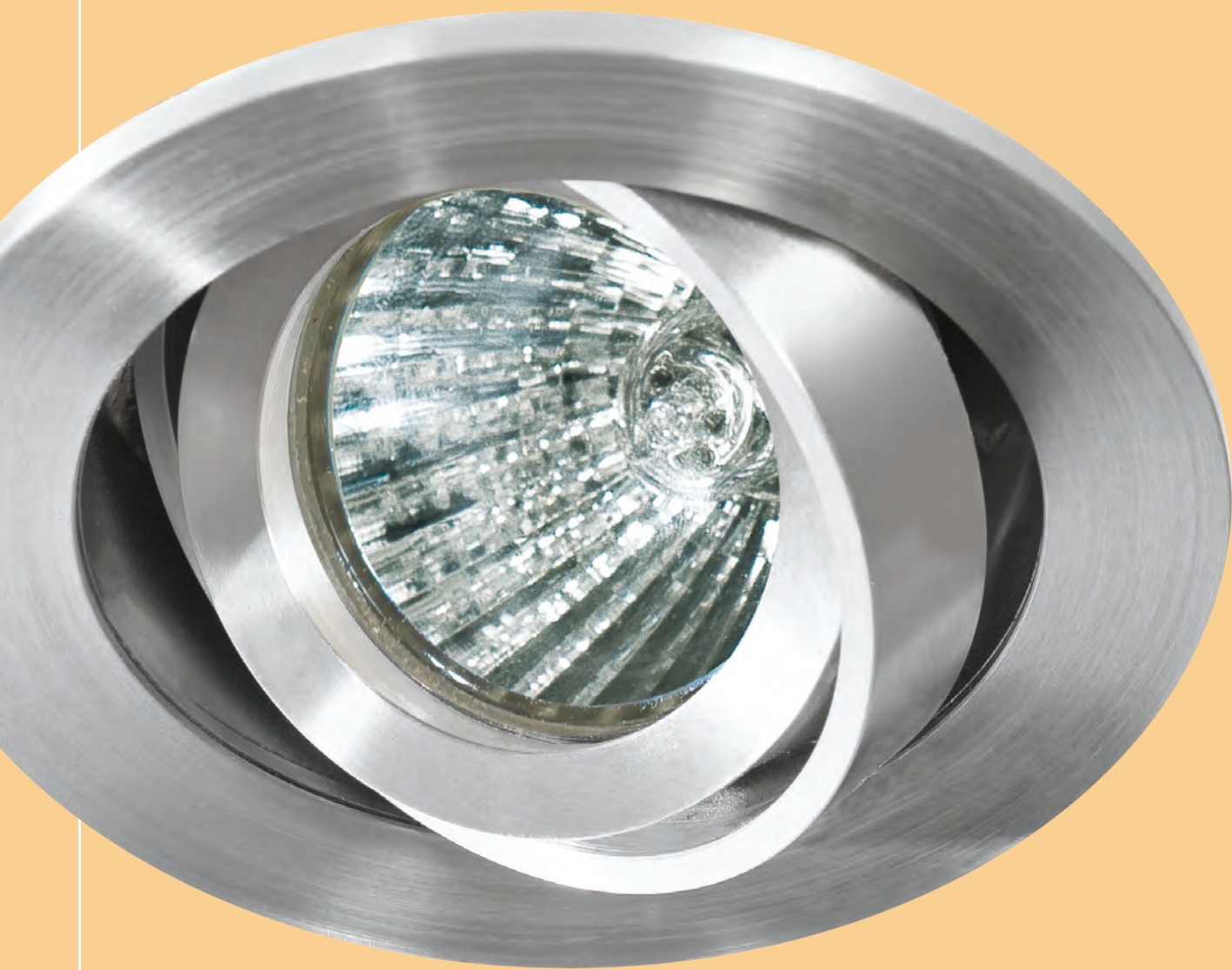

**DOWN**LIGHTS

# DOWNlights

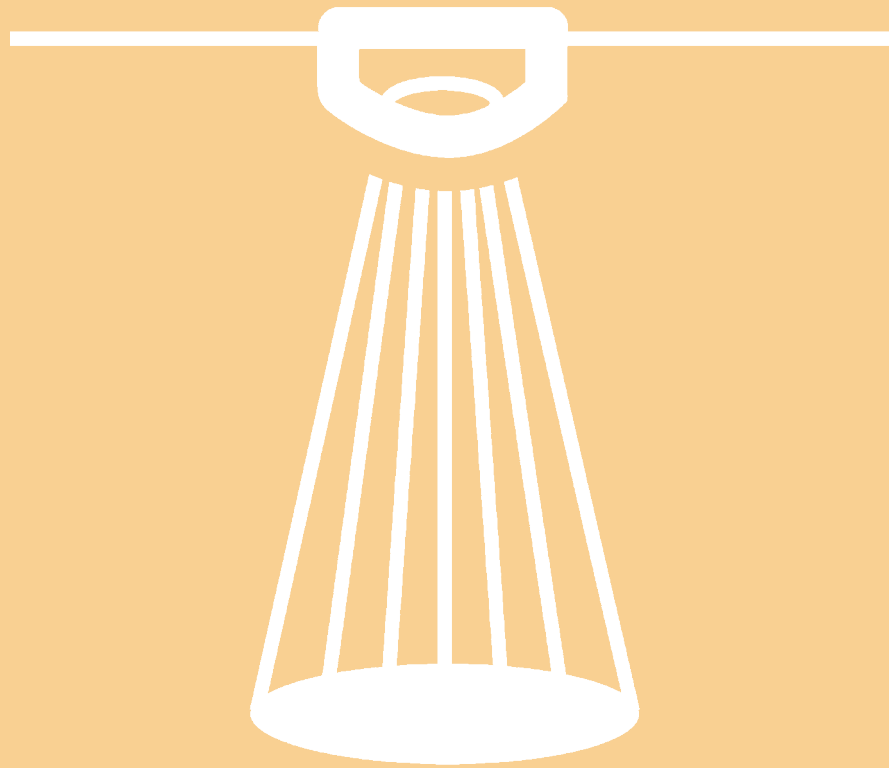

# CARO ROUND

108 Downlights



CARO R

bulb not included

voltage: 230V	GU10 x 1x MAX 50W <input type="checkbox"/>
IP20	
	installation place <input type="checkbox"/>
	inlet opening <input type="checkbox"/> Ø 7,8cm

COLOUR / NEW INDEX NO.

- GOLD (GO) . . . . . **AZ5424**
- ALUMINIUM (ALU) . . . . . **AZ2432**
- BLACK (BK) . . . . . **AZ2431**
- WHITE (WH) . . . . . **AZ2430**

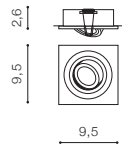

TILT 45°



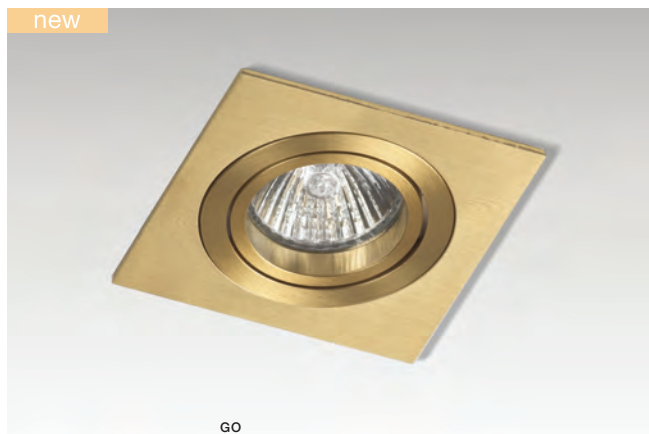

CARO S

bulb not included <input checked="" type="checkbox"/>	
voltage: 230V	GU10 x 1x MAX 50W <input checked="" type="checkbox"/>
IP20	
installation place <input checked="" type="checkbox"/>	
inlet opening <input checked="" type="checkbox"/> Ø8cm	

COLOUR / NEW INDEX NO.

- GOLD (GO) . . . . . **AZ5425**
- ALUMINIUM (ALU) . . . . . **AZ2435**
- BLACK (BK) . . . . . **AZ2434**
- WHITE (WH) . . . . . **AZ2433**

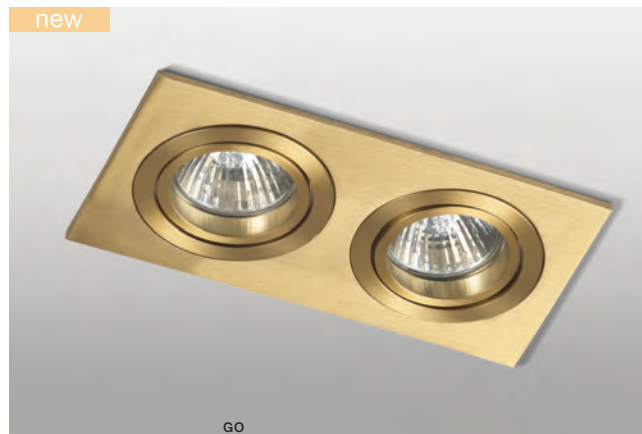
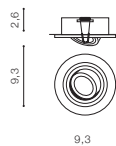

CARO 2S

bulb not included <input checked="" type="checkbox"/>	
voltage: 230V	GU10 x 2x MAX 50W <input checked="" type="checkbox"/>
IP20	
installation place <input checked="" type="checkbox"/>	
inlet opening <input checked="" type="checkbox"/> 8x15,8cm	

COLOUR / NEW INDEX NO.

- GOLD (GO) . . . . . **AZ5426**
- ALUMINIUM (ALU) . . . . . **AZ2438**
- BLACK (BK) . . . . . **AZ2437**
- WHITE (WH) . . . . . **AZ2436**

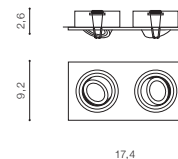

CARO 3S

bulb not includ <input checked="" type="checkbox"/>	
voltage: 230V	connect GU10 3x Max 50W <input checked="" type="checkbox"/>
IP20	
installation place <input checked="" type="checkbox"/>	
inlet opening <input checked="" type="checkbox"/> 8x23,5cm	

COLOUR / NEW INDEX NO.

- ALUMINIUM (ALU) . . . . . **AZ2441**
- BLACK (BK) . . . . . **AZ2440**
- WHITE (WH) . . . . . **AZ2439**

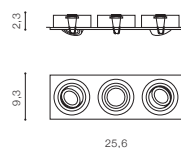

CARO 4S

bulb not includ <input checked="" type="checkbox"/>	
voltage: 230V	connect GU10 4x Max 50W <input checked="" type="checkbox"/>
IP20	
installation place <input checked="" type="checkbox"/>	
inlet opening <input checked="" type="checkbox"/> 16x16cm	

COLOUR / NEW INDEX NO.

- WHITE (WH) . . . . . **AZ2442**

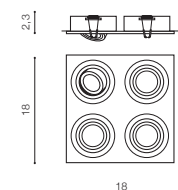





**AZzardo**<sup>®</sup>

OUTDOORLINE

[www.azzardolighting.com](http://www.azzardolighting.com)



# OUTDOOR LAMPS

# OUTDOOR

lamps

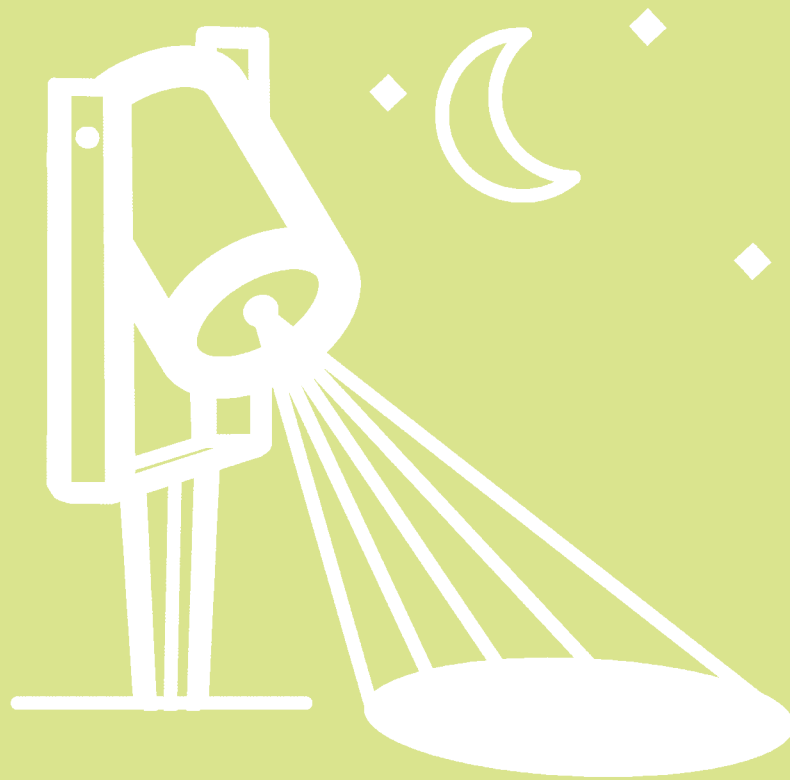

# JASON WALL IP65

114 Outdoor lamps



**JASON WALL IP65**

LED integrated	
voltage: 230V	LED 9W 800lm 4000K
IP65	 <b>LED</b>
technical specification	installation: <input type="checkbox"/>
	beam angle: 60° <input type="checkbox"/>

COLOUR / NEW INDEX NO.

- BLACK (BK) . . . . . **AZ5217**
- DARK GREY (DGR) . . . . . **AZ5218**



**JASON 2 WALL IP65**

LED integrated	
voltage: 230V	LED 2x 9W 1600lm 4000K
IP65	 <b>LED</b>
technical specification	installation: <input type="checkbox"/>
	beam angle: 2 x 60° <input type="checkbox"/>

COLOUR / NEW INDEX NO.

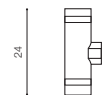

- BLACK (BK) . . . . . **AZ5219**
- DARK GREY (DGR) . . . . . **AZ5220**





JASON SQUARE WALL IP65

LED integrated

voltage: 230V	LED 9W 800lm 4000K		
IP65	technical		
	installation:		
	beam angle: 60°		

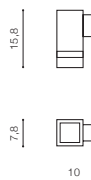

COLOUR / NEW INDEX NO.

- BLACK (BK) . . . . . **AZ5221**
- DARK GREY (DGR) . . . . . **AZ5222**



JASON 2 SQUARE WALL IP65

LED integrated

voltage: 230V	LED 2x 9W 1600lm 4000K		
IP65	technical		
	installation:		
	beam angle: 2 x 60°		

COLOUR / NEW INDEX NO.

- BLACK (BK) . . . . . **AZ5223**
- DARK GREY (DGR) . . . . . **AZ5224**

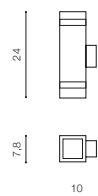

# ROLAND WALL IP65

116 Outdoor lamps



**ROLAND WALL IP65**

LED integrated

voltage: 230V	LED 9W 800lm 3000K	<b>LED</b>
IP65		
technical specification	installation:	<input type="checkbox"/>
	beam angle: 85°	<input checked="" type="checkbox"/>

COLOUR / NEW INDEX NO.

- WHITE (WH) . . . . . **AZ5226**
- DARK GREY (DGR) . . . . . **AZ5225**

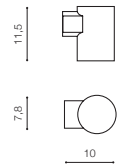

**ROLAND 2 WALL IP65**

LED integrated

voltage: 230V	LED 18W 1600lm 3000K	<b>LED</b>
IP65		
technical specification	installation:	<input type="checkbox"/>
	beam angle: 2 x 85°	<input checked="" type="checkbox"/>

COLOUR / NEW INDEX NO.

- WHITE (WH) . . . . . **AZ5228**
- DARK GREY (DGR) . . . . . **AZ5227**

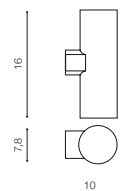

ROLAND SQ WALL IP65



WH

ROLAND SQ WALL IP65

LED integrated

voltage: 230V	LED 9W 800lm 3000K		<b>LED</b>
IP65	technical		
specification	installation: <input type="checkbox"/>	beam angle: 85°	<input type="checkbox"/>

COLOUR / NEW INDEX NO.

- WHITE (WH) . . . . . **AZ5230**
- DARK GREY (DGR) . . . . . **AZ5229**

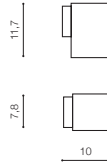

DGR

ROLAND 2 SQ WALL IP65

LED integrated

voltage: 230V	LED 18W 1600lm 3000K		<b>LED</b>
IP65	technical		
specification	installation: <input type="checkbox"/>	beam angle: 2 x 85	<input type="checkbox"/>

COLOUR / NEW INDEX NO.

- WHITE (WH) . . . . . **AZ5232**
- DARK GREY (DGR) . . . . . **AZ5231**

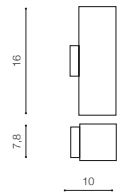

# ZARIA IP 65 CCT SWITCH

118 Outdoor lamps

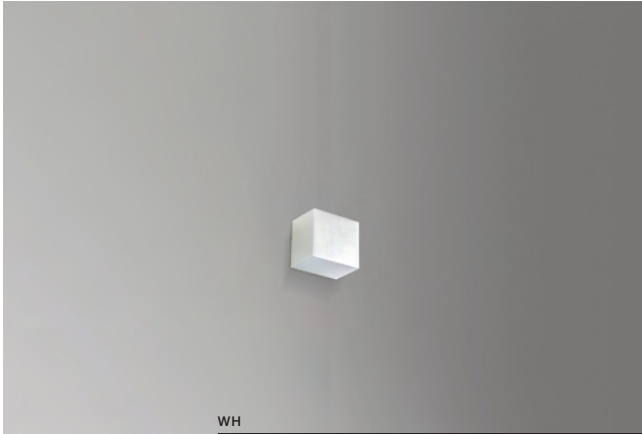

ZARIA A IP65 CCT SWITCH

LED integrated	
voltage: 230V	LED 5W 500 lm 3000K/4000K/6000K
IP65	CCT Switch <b>LED</b>
technical	installation:
specification	beam angle: 360°

COLOUR / NEW INDEX NO.

WHITE (WH). . . . . **AZ5233**

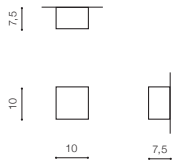

ZARIA B IP65 CCT SWITCH

LED integrated	
voltage: 230V	8W 800 lm 3000K/4000K/6000K
IP65	CCT Switch <b>LED</b>
technical	installation:
specification	beam angle: 360°

COLOUR / NEW INDEX NO.

WHITE (WH). . . . . **AZ5234**

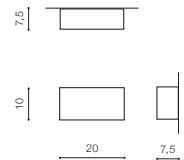

ZARIA C IP65 CCT SWITCH

LED integrated	
voltage: 230V	LED 15W 1500 lm
IP65	3000K/4000K/6000K CCT Switch <b>LED</b>
technical	installation:
specification	beam angle: 360°

COLOUR / NEW INDEX NO.

WHITE (WH). . . . . **AZ5235**

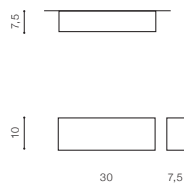

ZARIA D IP65 CCT SWITCH

LED integrated	
voltage: 230V	LED 20W 2000 lm
IP65	3000K/4000K/6000K CCT Switch <b>LED</b>
technical	installation:
specification	beam angle: 360°

COLOUR / NEW INDEX NO.

WHITE (WH). . . . . **AZ5236**

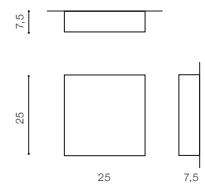



# ZARIA IP 65 CCT SWITCH

Outdoor lamps 119



# GILBERTO IP54

120 Outdoor lamps



## GILBERTO TABLE IP54

LED integrated

voltage: 230V	LED 2W 130lm 3000K dimm	<b>LED</b>
IP54		
technical specification	installation:	
	beam angle: 110°	

### COLOUR / NEW INDEX NO.

- BLACK (BK) . . . . . **AZ5335**
- WHITE (WH) . . . . . **AZ5334**
- CORTEN (CORT) . . . . . **AZ5336**

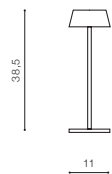





## BATTERY FOR GILBERTO TABLE IP54

How long does it take to fully charge:	<b>6-8hours</b>
What charger parameters are recommended:	Output <b>5V 1A</b>
What is the capacity of accumulator: It is lithium battery capacity	<b>18650*2 4400mA 3.7V</b>
How many charging cycles it lasts:	<b>500cycles</b>
After <b>300 cycles</b> of use and charging, the battery can still reach <b>80% capacity</b>	
Is the accu replaceable:	<b>Yes</b>
Others, like brightness memory function:	<b>Yes</b>





**FREDO 58 IP54 4000K**



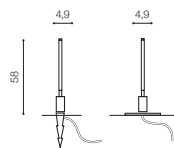

voltage: 230V	LED 6W 390lm 4000K	LED integrated
IP54		
technical specification	installation:	
	beam angle: 120°	

COLOUR / NEW INDEX NO.

■ BLACK (BK) . . . . . **AZ5337**



**FREDO 98 IP54 4000K**

voltage: 230V	LED 12W 780lm 4000K	LED integrated
IP54		
technical specification	installation:	
	beam angle: 120°	

COLOUR / NEW INDEX NO.

■ BLACK (BK) . . . . . **AZ5338**

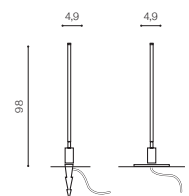

# GUIDO IP54

122 Outdoor lamps

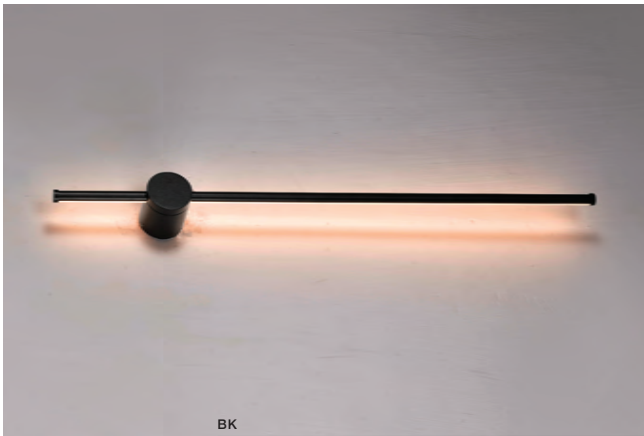

BK

## GUIDO WALL IP54 3000K

LED integrated

voltage: 230V	LED 12W 780lm 3000K	<b>LED</b>
IP54		
technical	installation:	<input type="checkbox"/>
specification	beam angle: 120°	<input checked="" type="checkbox"/>

COLOUR / NEW INDEX NO.

■ BLACK (BK) . . . . . **AZ5339**

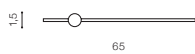
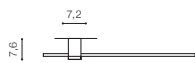

DURANTE IP54

Outdoor lamps 123

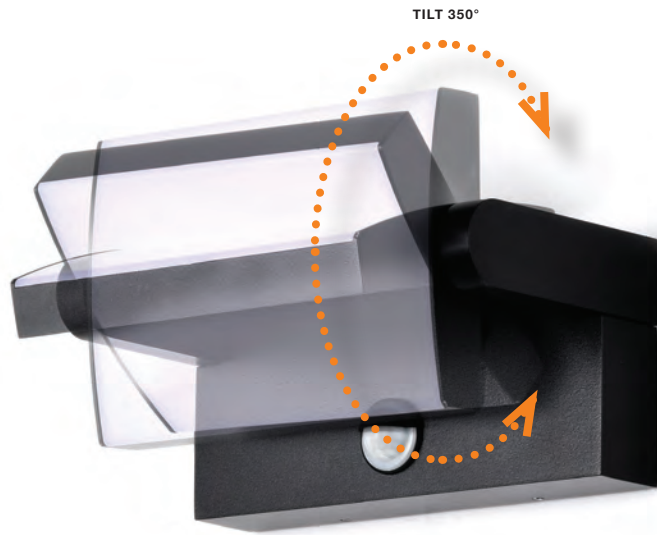

DURANTE IP54 SENSOR 4000K

LED integrated

voltage: 230V	LED 21W 1365lm 4000K	<b>LED</b>
IP54		
technical specification	installation:	<input type="checkbox"/>
	beam angle: 120°	<input type="checkbox"/>

COLOUR / NEW INDEX NO.

■ BLACK (BK) . . . . . **AZ5340**

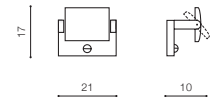

TILT 350°



# ROMOLO R IP65

124 Outdoor lamps



## ROMOLO R IP65

bulb not included

voltage: 230V	GU10 x MAX 50W <input checked="" type="checkbox"/>
IP65	
	instalation place: <input checked="" type="checkbox"/>

### COLOUR / NEW INDEX NO.

- BLACK (BK) . . . . . **AZ5390**
- WHITE (WH) . . . . . **AZ5389**

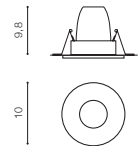

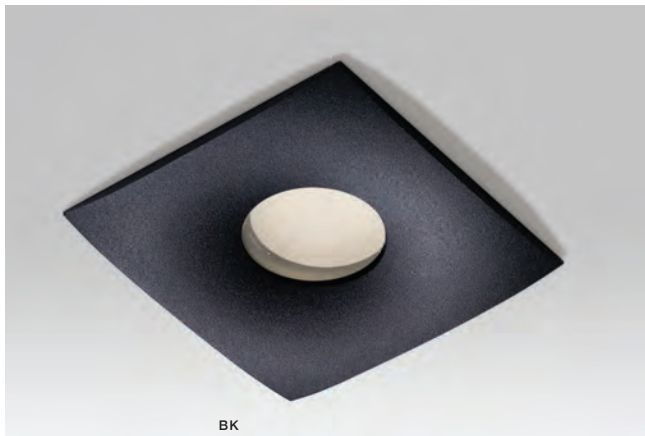

BK



**ROMOLO S IP65**

bulb not included

voltage: 230V	GU10 x MAX 50W	
IP65	installation place:	

COLOUR / NEW INDEX NO.

- BLACK (BK) . . . . . **AZ5392**
- WHITE (WH) . . . . . **AZ5391**

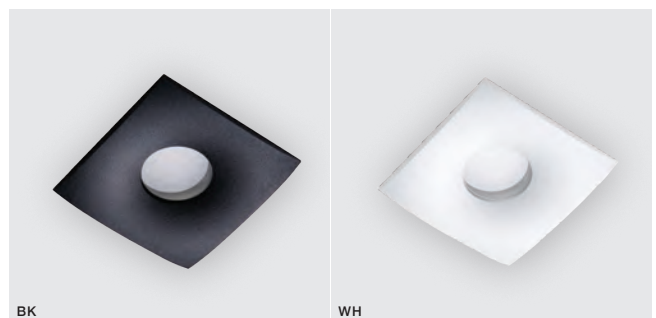
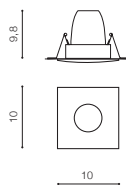

BK

WH